

2230 DIGITAL STORAGE OSCILLOSCOPE

*Please Check for
CHANGE INFORMATION
at the Rear of This Manual*

Copyright © 1985 Tektronix, Inc. All rights reserved.
Contents of this publication may not be reproduced in any
form without the written permission of Tektronix, Inc.

Products of Tektronix, Inc. and its subsidiaries are covered
by U.S. and foreign patents and/or pending patents.

TEKTRONIX, TEK, SCOPE-MOBILE, and  are
registered trademarks of Tektronix, Inc. TELEQUIPMENT
is a registered trademark of Tektronix U.K. Limited.

Printed in U.S.A. Specification and price change privileges
are reserved.

Page 1-5

REPETITIVE Store Mode

SAMPLE and AVERAGE	Single Trace	ALT
0.05 us per division	^a 100 MHz (-3 dB).	^a 100 MHz (-3 dB).
0.1 us per division	^a 100 MHz (-3 dB).	50 MHz (-3 dB).
0.2 us per division to 2 us per division (5% p-p maximum amplitude uncertainty)	10 ----- Hz SEC/DIV	5 ----- Hz SEC/DIV

Page 1-10

Storage Display
Expansion Algorithm
Error +-0.1% of full scale.

Storage Display
Compression
Algorithm Error +0.16% of reading +-0.4% of
full scale.

Page 1-10

SAVE Mode
Expansion Range

YT Mode 10 times as determined by the
X10 MAG switch.

Page 1-11

NON STORE Bandwidth
(-3 dB) Measured with a five-division
reference signal.

X-Axis DC to at least 2.5 MHz.

Certificate of the Manufacturer/Importer

We hereby certify that the 2230 OSCILLOSCOPE

AND ALL INSTALLED OPTIONS

complies with the RF Interference Suppression requirements of Amtsbl.-Vfg 1046/1984.

The German Postal Service was notified that the equipment is being marketed.

The German Postal Service has the right to re-test the series and to verify that it complies.

TEKTRONIX

Bescheinigung des Herstellers/Importeurs

Hiermit wird bescheinigt, daß der/die/das 2230 OSCILLOSCOPE

AND ALL INSTALLED OPTIONS

in Ubereinstimmung mit den Bestimmungen der Amtsblatt-Verfugung 1046/1984 funkentstort ist.

Der Deutschen Bundespost wurde das Inverkehrbringen dieses Gerates angezeigt und die Berechtigung zur Uberprufung der Serie auf Einhalten der Bestimmungen eingeräumt.

TEKTRONIX

NOTICE to the user/operator:

The German Postal Service requires that Systems assembled by the operator/user of this instrument must also comply with Postal Regulation, Vfg. 1046/1984, Par. 2, Sect. 1.

HINWEIS fur den Benutzer/Betreiber:

Die vom Betreiber zusammengestellte Anlage, innerhalb derer dies Gerat eingesetzt wird, muß ebenfalls den Voraussetzungen nach Par. 2, Ziff. 1 der Vfg. 1046/1984 genugen.

NOTICE to the user/operator:

The German Postal Service requires that this equipment, when used in a test setup, may only be operated if the requirements of Postal Regulation, Vfg. 1046/1984, Par. 2, Sect. 1.7.1 are complied with.

HINWEIS fur den Benutzer/Betreiber:

Dies Gerat darf in Meßaufbauten nur betrieben werden, wenn die Voraussetzungen des Par. 2, Ziff. 1.7.1 der Vfg. 1046/1984 eingehalten werden.

Page 1-13

EMI (Electromagnetic interference)

Meets radiated and conducted emission requirements per VDE 0871, Class B.

To meet EMI regulations and specifications, use the specified shielded cable and metal connector housing with the housing grounded to the cable shield on the AUXILIARY CONNECTOR.

Page 3-10

In STORE mode when the SGL SWP is armed, the acquisition cycle begins, but the READY LED does not come on until the pretrigger portion of the acquisition memory is filled. At the time the READY LED comes on, the acquisition system is ready to accept a trigger. When a trigger event occurs, the post-trigger waveform data is stored to complete the single-sweep acquisition. After the acquisition is completed, the READY LED goes out, and the single sweep can be rearmed.

Page 3-10

READY--TRIG'D Indicator

A dual-function LED indicator. In P-P AUTO and NORM Trigger modes, the LED is turned on when triggering occurs. In SGL SWP Trigger mode, the LED turns on when the A Trigger circuit is armed, awaiting a triggering event, and turns off again after the single sweep (or acquisition) completes.

In STORE mode, pressing the SGL SWP button to arm the trigger circuitry does not immediately turn on the READY LED. The pretrigger portion of the acquisition memory starts filling after the SGL SWP button is pressed in; the READY LED is turned on when the filling is completed. The storage acquisition system is then ready to accept a triggering event. After an acquisition is completed, the READY LED is turned off.

TABLE OF CONTENTS

	Page		Page
LIST OF ILLUSTRATIONS	iii	Section 5 OPERATOR'S CHECKS AND ADJUSTMENTS	
LIST OF TABLES	iv	INITIAL SETUP.....	5-1
OPERATORS SAFETY SUMMARY	v	TRACE ROTATION	
Section 1 GENERAL INFORMATION		ADJUSTMENT.....	5-2
INTRODUCTION.....	1-1	PROBE COMPENSATION.....	5-2
SPECIFICATION.....	1-1	HORIZONTAL ACCURACY	
Section 2 PREPARATION FOR USE		CHECK.....	5-3
SAFETY	2-1	Section 6 BASIC APPLICATIONS	
LINE VOLTAGE.....	2-1	INTRODUCTION	6-1
POWER CORD.....	2-1	OSCILLOSCOPE DISPLAYS.....	6-1
LINE FUSE	2-2	NON STORE DISPLAYS.....	6-1
INSTRUMENT COOLING.....	2-2	DIGITAL STORAGE DISPLAYS	6-3
START-UP	2-2	MAKING DIGITAL STORAGE	
REPACKAGING.....	2-3	MEASUREMENTS	6-5
Section 3 CONTROLS, CONNECTORS, AND INDICATORS		Ac Peak-To-Peak Voltage	
POWER AND DISPLAY	3-1	Using Cursors.....	6-5
VERTICAL	3-1	Ground Referenced Dc Voltage	6-5
HORIZONTAL.....	3-5	Time Duration	6-6
TRIGGER.....	3-9	Frequency	6-7
STORAGE CONTROLS	3-11	Rise Time.....	6-7
MENU SELECTED FUNCTIONS	3-14	Waveform Comparison.....	6-8
REAR PANEL	3-15	Time Difference Between	
SIDE PANEL.....	3-16	Repetitive Pulses	6-9
CRT READOUT	3-18	Time Difference Between Two	
Section 4 OPERATING CONSIDERATIONS		Time-Related Pulses.....	6-10
GRATICULE	4-1	Phase Difference Between	
GROUNDING	4-1	Sinusoidal Signals.....	6-10
SIGNAL CONNECTIONS	4-1	Slope.....	6-12
INPUT-COUPLING		Low-Level Signal	
CAPACITOR PRECHARGING	4-2	Measurements	6-12
		Observing and Removing	
		Aliases in Store Mode.....	6-13

TABLE OF CONTENTS (cont)

	Page		Page
MAKING NONSTORAGE		TV LINE SIGNAL.....	6-25
MEASUREMENTS	6-16	TV FIELD SIGNAL.....	6-25
AC PEAK-TO-PEAK VOLTAGE	6-16	DELAYED-SWEEP MAGNIFICATION .	6-25
GROUND REFERENCED DC		DELAYED-SWEEP TIME	
VOLTAGE	6-17	MEASUREMENTS	6-27
ALGEBRAIC ADDITION	6-18		
COMMON-MODE REJECTION.....	6-18		
TIME DURATION	6-19		
AMPLITUDE COMPARISON	6-20		
FREQUENCY	6-21		
RISE TIME	6-21		
TIME DIFFERENCE BETWEEN TWO			
TIME-RELATED PULSES	6-22		
PHASE DIFFERENCE	6-23		
TIME COMPARISON	6-24		
		Section 7 OPTIONS AND ACCESSORIES	
		INTRODUCTION.....	7-1
		STANDARD ACCESSORIES.....	7-1
		OPTIONAL ACCESSORIES.....	7-1
		POWER CORD OPTIONS.....	7-1
		CHANGE INFORMATION	

Page 3-12

POSITION CURS/SELECT WAVEFORM Switch--Determines the function of the CURSORS Position control. When pressed in (POSITION CURSORS mode), the CURSORS Position control functions as a cursor horizontal positioning control. When the push button is in the out position (SELECT WAVEFORM mode), the CURSORS Position control or the C1/C2 switch may be used to move the cursor set to the desired waveform(s).

Page 3-13

CURSORS Position Control--Provides for either horizontal positioning of the active cursor (or active cursors when there are two waveforms displayed in a display set) or for switching the cursors between waveform display sets. When cursors are positioned to a new waveform set, they return to the position that they had when they were last on that waveform set. Cursor positioning continues to function during SAVE mode, and measurements can be made on any displayed waveform. When an acquisition control is changed, the cursors return to the acquisition waveform set.

Cursors are placed on all waveforms in a display set. A display set is one or both waveforms from the following: Acquisition, CH 1 and CH 2; Reference 1, CH 1 and CH 2; Reference 2, CH 1 and CH 2; and Reference 3, CH 1 and CH 2. Cursors move to the acquisition waveform if they were on a SAVE REF waveform that is turned off. The acquisition parameters of the waveform set in which the cursors are located are displayed in the crt readout. Cursors movable by the CURSORS Position control are enclosed in a box.

Page 3-13

DELETE

When switching between BOTH (A INTEN in STORE mode) and B ONLY STORE displays, the active cursor is displayed. Cursors in the intensified zone on A INTEN traces switch to their correct relative positions in a B ONLY trace. An active cursor outside the A intensified zone switches to the nearest displayed end of the B ONLY trace. Upon switching back to A INTEN the cursor returns to the correct position in the intensified zone.

LIST OF ILLUSTRATIONS

Figure	Page
The 2230 Digital Storage Oscilloscope.....	vi
1-1 Maximum input voltage vs frequency derating curve for CH 1 OR X, CH 2 OR Y, and EXT INPUT connectors	1-14
1-2 Physical dimensions of the 2230 Oscilloscope.....	1-15
2-1 Securing the detachable power cord to the instrument.....	2-1
2-2 Optional power-cord data	2-2
2-3 Fuse holder and detachable power-cord connector	2-2
3-1 Power and display controls and power-on indicator.....	3-2
3-2 Vertical controls and connectors	3-3
3-3 Horizontal controls	3-6
3-4 Trigger controls, connector, and indicator.....	3-9
3-5 Storage controls.....	3-11
3-6 Rear panel.....	3-16
3-7 Side panel.....	3-16
3-8 X-Y Plotter interfacing.....	3-17
3-9 Crt readout display.....	3-18
4-1 Graticule measurement markings	4-1
5-1 Probe compensation.....	5-2
6-1 Ac peak-to-peak voltage, cursor method	6-5
6-2 Ground referenced dc voltage, cursor method.....	6-6
6-3 Time duration, cursor method.....	6-6
6-4 Rise-time setup, five-division display.....	6-7
6-5 Rise time, cursor method.....	6-8
6-6 Waveform comparison	6-9
6-7 Time difference between repetitive pulses.....	6-9
6-8 Time difference between two time-related pulses	6-10
6-9 Phase difference between sinusoidal signals	6-11
6-10 Slope using cursors.....	6-12
6-11 Low-level signal, STORE mode	6-13
6-12 Low-level signal, AVERAGE mode	6-13
6-13 Anti-aliasing	6-14
6-14 Glitch display, ACCPEAK Store mode.....	6-14
6-15 Glitch display, STORE mode using B HORIZONTAL MODE	6-15
6-16 Missing Pulse, ACCPEAK STORE mode	6-16
6-17 Peak-to-peak waveform voltage	6-17
6-18 Ground-referenced voltage measurement	6-18

LIST OF ILLUSTRATIONS (cont)

Figure	Page
6-19 Algebraic addition	6-19
6-20 Common-mode rejection	6-19
6-21 Time duration.....	6-20
6-22 Rise time.....	6-21
6-23 Time difference between two time-related pulses	6-22
6-24 Phase difference	6-23
6-25 High-resolution phase difference.....	6-24
6-26 Delayed-sweep magnification.....	6-26
6-27 Time difference between repetitive pulses.....	6-27
6-28 Rise time, differential time method	6-28
6-29 Time difference between two time-related pulses, differential time method.....	6-29

LIST OF TABLES

Table	Page
1-1 Electrical Characteristics	1-3
1-2 Environmental Characteristics	1-13
1-3 Physical Characteristics	1-14
3-1 Probe Coding.....	3-4
3-2 Default Digital Storage Modes.....	3-6
3-3 Repetitive Store Sampling Data Acquisition.....	3-7
3-4 Auxiliary Connector	3-16

Page 3-13

SELECT C1/C2 (Cursor-Select) Switch--In Position CURS mode this switch selects the cursor(s) that can be positioned by the CURSORS Position control. Cursors are activated alternately with each press of the C1/C2 button. Each selected cursor is enclosed in a box. In Select Waveform mode, pressing the C1/C2 switch moves the cursor set between displayed waveforms.

Page 3-13

SAVE REF/----> Switch--Pressing this button just prior to pressing one of the DISPLAY ON/OFF buttons writes the displayed acquisition waveform into the selected Save Reference memory. The written waveform remains displayed on the crt. A control change or a delay of five seconds between pressing the SAVE REF button and selecting a memory location cancels the SAVE request.

In 4K Acquisition mode, a choice may be made to save the entire 4K acquisition or the 1K displayed window. To save the 4K acquisition, press SAVE REF, then press DISPLAY ON/OFF 1 twice. The 4K record fills MEMORY 1, 2, and 3. To save only the 1K display window, press SAVE REF, then press DISPLAY ON/OFF 1, then DISPLAY ON/OFF 2. The 1K display window may also be saved in MEMORY 2 or 3 by pressing SAVE REF, then the desired DISPLAY ON/OFF button.

Menu Select/DISPLAY ON/OFF Switches--These buttons select one of three memories that is either written to for saving a 1K acquisition waveform (if SAVE REF has been pressed) or toggles the reference memory display on or off (if the SAVE button has not been pressed). The stored waveforms of all three memories can be displayed at the same time. Two channels acquired in CHOP or ALT may be stored in a SAVE REF memory.

Page 3-14

SWP LIMIT--Selects the number of acquisitions before the acquisition system halts in either ACCPEAK or AVERAGE. SWP LIMIT may be reset by changing any acquisition control.

OPERATORS SAFETY SUMMARY

The general safety information in this part of the summary is for both operating and servicing personnel. Specific warnings and cautions will be found throughout the manual where they apply and do not appear in this summary.

Terms in This Manual

CAUTION statements identify conditions or practices that could result in damage to the equipment or other property.

WARNING statements identify conditions or practices that could result in personal injury or loss of life.

Terms as Marked on Equipment

CAUTION indicates a personal injury hazard not immediately accessible as one reads the markings, or a hazard to property, including the equipment itself.

DANGER indicates a personal injury hazard immediately accessible as one reads the marking.

Symbols in This Manual



This symbol indicates where applicable cautionary or other information is to be found. For maximum input voltage see Table 1-1.

Symbols as Marked on Equipment



DANGER — High voltage.



Protective ground (earth) terminal.



ATTENTION — Refer to manual.

Power Source

This product is intended to operate from a power source that does not apply more than 250 volts rms between the supply conductors or between either supply conductor and ground. A protective ground connection by way of the grounding conductor in the power cord is essential for safe operation.

Grounding the Product

This product is grounded through the grounding conductor of the power cord. To avoid electrical shock, plug the power cord into a properly wired receptacle before connecting to the product input or output terminals. A protective ground connection by way of the grounding conductor in the power cord is essential for safe operation.

Danger Arising from Loss of Ground

Upon loss of the protective-ground connection, all accessible conductive parts (including knobs and controls that may appear to be insulating) can render an electric shock.

Use the Proper Power Cord

Use only the power cord and connector specified for your product.

Use only a power cord that is in good condition.

For detailed information on power cords and connectors, see Figure 2-2.

Use the Proper Fuse

To avoid fire hazard, use only a fuse of the correct type, voltage rating and current rating as specified in the parts list for your product.

Do Not Operate in Explosive Atmospheres

To avoid explosion, do not operate this product in an explosive atmosphere unless it has been specifically certified for such operation.

Do Not Remove Covers or Panels

To avoid personal injury, do not remove the product covers or panels. Do not operate the product without the covers and panels properly installed.

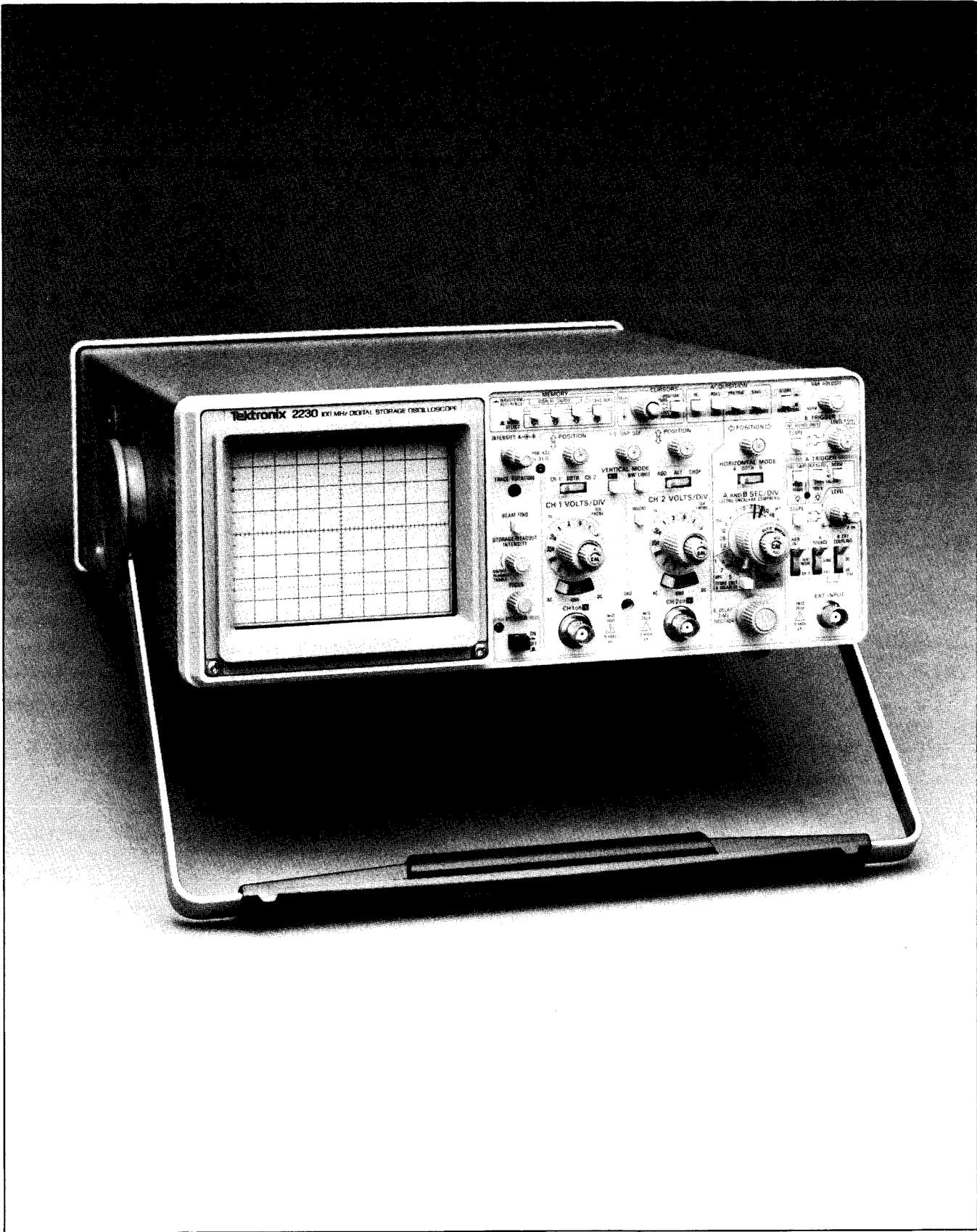

4998-01

The 2230 Digital Storage Oscilloscope.

TEKTRONIX

MANUAL CHANGE INFORMATION

Date: 10/10/85

Change Reference:

Product: 2230 OPERATORS

Manual Part No.: 070-4998-00

 DESCRIPTION Product Group 46

EFFECTIVE ALL SERIAL NUMBERS

TEXT CHANGES

Page 1-4

Useful storage performance is limited to the frequency where there are 10 samples per sine wave signal period at the maximum sampling rate. (Maximum sampling rate is 20 MHz in Single trace and 10 MHz in CHOP or ALT at a SEC/DIV setting of 5 us/div.) This yields a maximum amplitude uncertainty of 5%. Accuracy at the useful storage bandwidth limit is measured with respect to a six-division 50 kHz reference sine wave.

PEAK DETECT	Single Trace and ALT	CHOP
Sine-wave Amplitude Capture (5% p-p maximum amplitude uncertainty)	1 MHz	1 MHz

GENERAL INFORMATION

INTRODUCTION

The TEKTRONIX 2230 Oscilloscope is a combination nonstorage and digital storage dual-channel 100 MHz bandwidth instrument. It is a rugged, lightweight oscilloscope featuring microprocessor operation and alphanumeric crt readout of many of the front-panel controls. In the digital storage mode, up to three waveform sets (CH 1 and/or CH 2) may be stored in a SAVE REF memory and recalled for display at a later time. The vertical system provides calibrated deflection factors from 2 mV per division to 5 V per division. The horizontal system provides calibrated sweep speeds from 50 ns per division to 0.5 s per division for nonstorage mode with three slower sweep speeds (1 s, 2 s, and 5 s per division) added for store mode operation. A X10 magnifier extends the maximum sweep speed to 5 ns per division.

The digital storage sampling rate is 20 megasamples per second maximum, and the acquired record length is 4K samples (1K may also be selected) for a single channel or 2K samples for dual-channel (CHOP or ALT) displays. Any contiguous 1K sample of an acquired record is displayable. The fast sampling rate can capture a glitch with a pulse width of at least 100 ns. A 4K compress feature enables a 4K record length acquisition to be compressed to 1K in length for ease in viewing or storing in the SAVE REF memory. If compression is not desired, all 4K or any 1K portion of a 4K record may be stored in the SAVE REF memory. The SAVE store mode stops the waveform acquisition in progress, allowing a particular display to be stored or examined before further acquisitions cause a waveform update.

Cursors may be used to obtain voltage measurements, time difference measurements, and delay-time measurements on any of the store mode waveform displays. Delta volts, delay time, delta time, and 1/delta time (either delta time or 1/delta time is selectable via the MENU) are displayed in the crt readout for ease in obtaining precise measurement results. The cursors are positioned to any displayed store mode waveform to make measurements. An alternate use of the cursor-positioning control is to horizontally position the 1K display window to any location within a 4K record length waveform acquisition. The displayed portion of a 4K acquisition is stored when the SAVE REF feature is used.

The instrument is shipped with the following standard accessories:

- 1 Operators Manual
- 1 Users Reference Guide
- 2 Probe Packages
- 1 Front Panel Cover
- 1 Accessory Pouch
- 1 Power Cord
- 1 Fuse
- 1 DB-9 Female Connector
- 1 DB-9 Connector Shell
- 1 Loop Clamp
- 1 Flat Washer
- 1 Self-Tapping Screw

For part numbers and further information about both standard and optional accessories, refer to "Options and Accessories" (Section 7) of this manual. Your Tektronix representative, local Tektronix Field Office, or Tektronix products catalog can also provide additional accessories information.

SPECIFICATION

The following electrical characteristics (Table 1-1) are valid when the instrument has been adjusted at an ambient temperature between +20°C and +30°C, has had a warm-up period of at least 20 minutes, and is operating at an ambient temperature between 0°C and +50°C (unless otherwise noted).

Items listed in the "Performance Requirements" column are verifiable qualitative or quantitative limits that define the measurement capabilities of the instrument.

Environmental characteristics are given in Table 1-2. This instrument meets the requirements of MIL-T-28800C for Type III, Class 5 equipment, except where noted otherwise.

Physical characteristics of the instrument are listed in Table 1-3.

General Information—2230 Operators

Finite resolution affects any measurement using discrete numbers. All digital storage stores amplitude values as discrete numbers and associates those amplitude numbers with discretely numbered times. Many measurements must be rounded or truncated. The size of the truncation or rounding becomes a part of the measurement error. For example, the following line is 1.5 units long. If it must be drawn as a line connecting points one unit apart, then it may be drawn as a line one unit long or two units long, depending on how it occurs relative to the points.

Case 1: Line approaches three points:

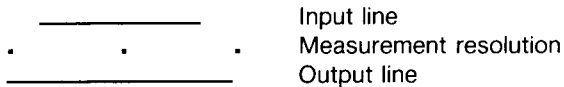

Case 2: Line approaches two points:

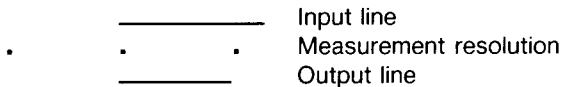

There are several places where measurements are quantified, and a one-count error in the measurement cannot be detected. The input channels are digitized to an 8-bit resolution, where one division is (ignoring expansion and compression) 25 counts. This means there is an inherent error of 1/25 of a division in any voltage measurement at acquisition time. Averaging can increase the resolution of a voltage measurement above the sampler's eight-bit limit. To use the increased resolution, the display has a 10-bit dynamic range in the vertical axis, as well as

the horizontal axis. An averaged signal has a resolution of 100 points per division (ignoring expansion and compression). In addition, the averaged number is stored with up to twelve bits of resolution. Expansion is required to view the eleventh and twelfth bits of increased resolution.

Time is quantified to determine when each sample occurred and which display interval gets each sample. Time is resolved by storing, for example, 4K points. If 4K points are stored, 4K time intervals are represented. However, in 4K mode, not all of the 4K-point resolution may be displayed on the 10-bit (1K-point) screen. Therefore, if 4K COMPRESS is selected to present the whole picture on-screen at once, only 1K resolution remains in the display. When peak-detected information is acquired, events with high-frequency content such as fast steps, or short pulses, can only be located within the time interval from which the peaks came. Even though two display points result from the interval, the event cannot be tied with certainty to the first or second point in the interval.

Time is also quantified to determine where to put points in REPETITIVE acquisitions, where the points acquired at 50 ns intervals fill only part of the screen. A counting device produces a number to represent the portion of 50 ns between the samples acquired and the ones that would have included the trigger. This number ranges from 0 to about 205, which allows accurate placement into the display record. The display record will have at most 100 slots to choose from on the basis of the 0-205 number (this is where each slot represents 0.5 ns of acquisition time, and the counter's resolution is about 0.244 ns per count).

MANUAL CHANGE INFORMATION

At Tektronix, we continually strive to keep up with latest electronic developments by adding circuit and component improvements to our instruments as soon as they are developed and tested.

Sometimes, due to printing and shipping requirements, we can't get these changes immediately into printed manuals. Hence, your manual may contain new change information on following pages.

A single change may affect several sections. Since the change information sheets are carried in the manual until all changes are permanently entered, some duplication may occur. If no such change pages appear following this page, your manual is correct as printed.

Table 1-1
Electrical Characteristics

Characteristics	Performance Requirements				
VERTICAL DEFLECTION SYSTEM					
Deflection Factor					
Range	2 mV/div to 5 V/div in a 1-2-5 sequence.				
DC Accuracy (NON STORE)					
+15°C to +35°C	Within ±2%.				
0°C to +50°C	Within ±3%. For 5 mV/div to 5 V/div VOLTS/DIV switch settings, the gain is set at a VOLTS/DIV switch setting of 10 mV/div. 2 mV/div gain is set with the VOLTS/DIV switch set to 2 mV/div.				
On Screen DC Accuracy (STORE)					
+15°C to +35°C	Within ±2%.				
0°C to +50°C	Within ±3%. STORE Mode gain set with the VOLTS/DIV switch set to 5 mV/div.				
Storage Acquisition Vertical Resolution	8 bits, 25 levels per division. 10.24 divisions dynamic range.				
Range of VOLTS/DIV Variable Control	Continuously variable between settings. Increases deflection factor by at least 2.5 to 1.				
Step Response (NON STORE)					
Rise Time					
0°C to +35°C					
5 mV/div to 5 V/div	3.5 ns or less.				
2 mV/div	4.4 ns or less.				
+35°C to +50°C					
5 mV/div to 5 V/div	3.9 ns or less.				
2 mV/div	4.4 ns or less. Rise time is calculated from: $\text{Rise Time} = \frac{0.35}{\text{Bandwidth} (-3 \text{ dB})}$				
Step Response (STORE Mode)					
Useful Storage Rise Time					
SAMPLE	<table style="width: 100%; border: none;"> <tr> <td style="text-align: center;">Single Trace</td> <td style="text-align: center;">CHOP/ALT</td> </tr> <tr> <td style="text-align: center;">$\frac{\text{SEC/DIV} \times 1.6}{100} \text{ s}$</td> <td style="text-align: center;">$\frac{\text{SEC/DIV} \times 1.6}{50} \text{ s}$</td> </tr> </table>	Single Trace	CHOP/ALT	$\frac{\text{SEC/DIV} \times 1.6}{100} \text{ s}$	$\frac{\text{SEC/DIV} \times 1.6}{50} \text{ s}$
Single Trace	CHOP/ALT				
$\frac{\text{SEC/DIV} \times 1.6}{100} \text{ s}$	$\frac{\text{SEC/DIV} \times 1.6}{50} \text{ s}$				
PEAKDET or ACCPEAK with SMOOTH	<table style="width: 100%; border: none;"> <tr> <td style="text-align: center;">$\frac{\text{SEC/DIV} \times 1.6}{50} \text{ s}$</td> <td style="text-align: center;">$\frac{\text{SEC/DIV} \times 1.6}{25} \text{ s}$</td> </tr> </table> <p>Rise time is limited to 3.5 ns minimum with derating over temperature (see NON STORE Rise Time).</p>	$\frac{\text{SEC/DIV} \times 1.6}{50} \text{ s}$	$\frac{\text{SEC/DIV} \times 1.6}{25} \text{ s}$		
$\frac{\text{SEC/DIV} \times 1.6}{50} \text{ s}$	$\frac{\text{SEC/DIV} \times 1.6}{25} \text{ s}$				

Table 1-1 (cont)

Characteristics	Performance Requirements	
Aberrations (NON STORE and STORE in SAMPLE Mode) 2 mV/div to 0.5 V/div	+4%, -4%, 4% p-p.	
1 V/div to 5 V/div	+12%, -12%, 12% p-p. Measured with a five-division reference signal, from a 50 Ω source driving a 50 Ω coaxial cable terminated in 50 Ω at the input connector with the VOLTS/DIV Variable control in the CAL detent. Vertically center the top of the reference signal.	
NON STORE Bandwidth (-3 dB) 0°C to +35°C 5 mV/div to 5 V/div	DC to at least 100 MHz.	
2 mV/div	DC to at least 80 MHz.	
+35°C to +50°C 5 mV/div to 5 V/div	DC to at least 90 MHz.	
2 mV/div	DC to at least 80 MHz. Measured with a vertically centered six-division reference signal, from a 50 Ω source driving a 50 Ω coaxial cable terminated in 50 Ω at the input connector; with the VOLTS/DIV Variable control in the CAL detent.	
NON STORE BW LIMIT (-3 dB)	20 MHz ± 10%.	
AC Coupled Lower Cutoff Frequency	10 Hz or less at -3 dB.	
Useful Storage Performance RECORD, SCAN and ROLL Store Modes SAMPLE Acquisition, no AVERAGE 5 μs/div to 5 s/div EXT CLOCK (up to 1 kHz)	Single Trace $\frac{10}{\text{SEC/DIV}}$ Hz $\frac{\text{EXT}}{10}$ Hz	CHOP/ALT $\frac{5}{\text{SEC/DIV}}$ Hz $\frac{\text{EXT}}{20}$ Hz
	Useful storage performance is limited to the frequency where there are 10 samples per sine wave signal period at the maximum sampling rate. (Maximum sampling rate is 20 MHz in Single trace and 10 MHz in CHOP or ALT at a SEC/DIV setting of 5 μs/div.) This yields a maximum amplitude uncertainty of 2%. Accuracy at the useful storage bandwidth limit is measured with respect to a six-division 50 kHz reference sine wave.	
PEAK DETECT Sine-Wave Amplitude Capture (2% p-p maximum amplitude uncertainty) Pulse Width Amplitude Capture (50% p-p maximum amplitude uncertainty)	Single Trace and ALT 1 MHz 100 ns	CHOP 1 MHz $\frac{\text{SEC/DIV}}{50}$

DESCRIPTION

Product Group 46

EFFECTIVE ALL SERIAL NUMBERS

TEXT CHANGES

Page 1-11 Replace the CURSOR Accuracy Specifications

CURSOR Accuracy	
Voltage Difference	Within $\pm 3\%$ of the ΔV Readout value.
Time Difference	
RECORD or ROLL/SCAN	
SAMPLE or AVERAGE	± 1 display interval
PEAKDET or ACCPEAK	± 2 display intervals
REPETITIVE	
SAMPLE or AVERAGE	$\pm (2 \text{ display intervals} + 0.5\text{ns})$
ACCPEAK	$\pm (4 \text{ display intervals} + 0.5\text{ns})$
A display interval is the time between two adjacent display points on a waveform.	

Table 1-1 (cont)

Characteristics	Performance Requirements	
REPETITIVE Store Mode		
NORMAL and AVERAGE	Single Trace	ALT
0.05 $\mu\text{s}/\text{div}$	100 MHz (–3 dB) ^a	100 MHz (–3 dB) ^a
0.1 $\mu\text{s}/\text{div}$	100 MHz (–3 dB) ^a	50 MHz (–3 dB)
0.2 $\mu\text{s}/\text{div}$ to 2 $\mu\text{s}/\text{div}$ (2% maximum amplitude uncertainty)	$\frac{10}{\text{SEC/DIV}}$ Hz	$\frac{5}{\text{SEC/DIV}}$ Hz
ACCPEAK		
0.05 $\mu\text{s}/\text{div}$ to 5 s/div	Same as NON STORE. Five-division reference signal, vertically centered; SEC/DIV switch set to 5 ms/div.	
AVERAGE Mode		
Sweep Limit	Adjustable from 1 to 2047 or NO LIMIT.	
Weight of Last Acquisition	1/2, 1/4, 1/8, 1/16, 1/32, 1/64, 1/128, or 1/256 (MENU selections). AVERAGE mode default weight is 1/4.	
Resolution	Assuming uncorrelated triggers and greater than 1 LSB of the 8-bit acquisition of vertical signal noise; the averaging weight for the first acquisition is 1, the averaging weight for the second acquisition is 1/2 and for n acquisitions is $1/2^{n-1}$. The MENU selects the least weight used. Maximum signal-to-noise improvement is achieved after $2 \times (\text{weight factor}) \times (\text{expected acquisitions to fill})$.	
Frequency Response	Frequency response of the AVERAGE Storage Mode is a function of the number of triggered acquisitions added to the weighted average. Time jitter of a signal with respect to the sample clock will produce a low-pass filter characteristic of an averaged waveform.	
NON STORE CHOP Mode Switching Rate	500 kHz \pm 30%.	
STORE Chop Rate		
SAMPLE	50/(SEC/DIV) for sweep speeds from 5 s per division to and including 10 μs per division.	
PEAK DETECT	25/(SEC/DIV) for sweep speeds from 5 s per division to and including 20 μs per division.	
5 $\mu\text{s}/\text{div}$ through 0.05 $\mu\text{s}/\text{div}$	No CHOP mode; acts as in ALT.	
A/D Converter Linearity	Monotonic with no missing codes.	
STORE Mode Cross Talk	<1% measured in CHOP.	

^aOne-hundred MHz bandwidth is derated for temperature outside 0°C to 35°C and at 2 mV/div VOLTS/DIV as for NON STORE.

Table 1-1 (cont)

Characteristics	Performance Requirements
NON STORE Common-Mode Rejection Ratio (CMRR)	At least 10 to 1 at 50 MHz. Checked at 10 mV per division for common-mode signals of six divisions or less with the VOLTS/DIV Variable control adjusted for the best CMRR at 50 kHz.
Input Current	1 nA or less (0.5 division or less trace shift when switching between DC and GND input coupling with the VOLTS/DIV switch set to 2 mV per division.
Input Characteristics Resistance Capacitance	1 MΩ ± 2%. 20 pF ± 2 pF.
Maximum Safe Input Voltage (CH 1 and CH 2) DC and AC Coupled 	See Figure 1-1 for maximum input voltage vs frequency derating curve. 400 V (dc + peak ac) or 800 V ac p-p at 10 kHz or less.
NON STORE Channel Isolation	Greater than 100 to 1 at 50 MHz.
STORE Channel Isolation	100 to 1 at 50 MHz.
POSITION Control Range	At least ± 11 divisions from graticule center.
A/B SWP SEP Control Range (NON STORE Mode Only)	± 3.5 divisions or greater.
Trace Shift with VOLTS/DIV Switch Rotation	0.75 division or less; VOLTS/DIV Variable control in the CAL detent.
Trace Shift as the VOLTS/DIV Variable Control is Rotated	1 division or less.
Trace Shift with INVERT	1.5 divisions or less.

DESCRIPTION

Product Group 46

EFFECTIVE ALL SERIAL NUMBERS

TEXT CHANGES

Page 1-4

Aberrations (NON STORE and STORE in SAMPLE Mode)

2mV/div to 50mV/div

+4%, -4%, 4% p-p.
3% or less at +25°C with cabinet installed.

0.1V/div to 0.5V/div

+6%, -6%, 6% p-p.
5% or less at +25°C with cabinet installed.

1V/div to 5V/div

+12%, -12%, 12% p-p.
10% or less at +25°C with cabinet installed.
Measured with a five-division reference signal, from a 50 Ω source driving a 50 Ω coaxial cable terminated in 50 Ω at the input connector with the VOLTS/DIV Variable control in the CAL detent. Vertically center the top of the reference signal.

Page 1-5

STORE Mode Cross Talk

<2% measured in CHOP at 10μs/div and 10mV/div using a 100kHz square wave signal vertically centered and the other input coupling set to ground.

Table 1-1 (cont)

Characteristics	Performance Requirements		
TRIGGERING SYSTEM			
A Trigger Sensitivity			
P-P AUTO and NORM	10 MHz	60 MHz	100 MHz
Internal	0.35 div	1.0 div	1.5 div
External	40 mV	120 mV	150 mV
	External trigger signal from a 50 Ω source driving a 50 Ω coaxial cable terminated in 50 Ω at the input connector.		
HF REJ Coupling	Reduces trigger signal amplitude at high frequencies by about 20 dB with rolloff beginning at 40 kHz ± 15 kHz. Should not trigger with a one-division peak-to-peak 250 kHz signal when HF REJ is ON.		
P-P AUTO Lowest Usable Frequency	20 Hz with 1 division internal or 100 mV external.		
TV LINE			
Internal	0.35 div.		
External	35 mV p-p.		
TV FIELD	≥ 1 division of composite sync.		
B Trigger Sensitivity (Internal Only)	10 MHz	60 MHz	100 MHz
	0.35 div	1.0 div	1.5 div
EXT INPUT			
Maximum Input Voltage 	400 V (dc + peak ac) or 800 V ac p-p at 10 kHz or less. See Figure 1-1 for maximum input voltage vs frequency derating curve.		
Input Resistance	1 MΩ ± 2%.		
Input Capacitance	20 pF ± 2.5 pF.		
AC Coupled Lower Cutoff Frequency	10 Hz or less at -3 dB.		
LEVEL Control Range			
A Trigger (NORM)			
INT	May be set at any voltage level of the trace that can be displayed.		
EXT, DC	At least ± 1.6 V, 3.2 V p-p.		
EXT, DC ÷ 10	At least ± 16 V, 32 V p-p.		
B Trigger (Internal)	May be set at any point of the trace that can be displayed.		
VAR HOLDOFF Control (NON STORE Holdoff)	Increases NON STORE A Sweep holdoff time by at least a factor of 10. STORE holdoff is a function of microprocessor activity and the pretrigger acquisition. The VAR HOLDOFF control maintains some control over the STORE holdoff by preventing a new trigger from being accepted by the storage circuitry until the next (or current, if one is in progress) NON STORE holdoff has completed.		
Acquisition Window Trigger Point			
PRETRIG	Seven-eighths of the waveform acquisition window is prior to the trigger (other trigger points are selectable via the MENU).		
POST TRIG	One-eighth of the waveform acquisition window is prior to the trigger (other trigger points are selectable via the MENU).		

Table 1-1 (cont)

Characteristics	Performance Requirements	
HORIZONTAL DEFLECTION SYSTEM		
NON STORE Sweep Rates		
Calibrated Range		
A Sweep	0.5 sec per division to 0.05 μ s per division in a 1-2-5 sequence of 22 steps. ^b	
B Sweep	50 ms per division to 0.05 μ s per division in a 1-2-5 sequence of 19 steps. ^b	
STORE Mode Ranges		
REPETITIVE	0.05 μ s per division to 2 μ s per division. ^c	
RECORD	5 μ s per division to 50 ms per division. ^c	
ROLL/SCAN	0.1 s per division to 5 s per division (A sweep only). ^c	
NON STORE Accuracy		
+15°C to +35°C	Unmagnified Within $\pm 2\%$	Magnified Within $\pm 3\%$
0°C to +50°C	Within $\pm 3\%$	Within $\pm 4\%$
	Sweep accuracy applies over the center eight divisions. Exclude the first 25 ns of the sweep for magnified sweep speed and anything beyond the 100th magnified division.	
STORE Accuracy	See Horizontal Differential Accuracy and Cursor Time Difference Accuracy.	
NON STORE Sweep Linearity	$\pm 5\%$. Linearity measured over any two of the center eight divisions. Exclude the first 25 ns and anything past the 100th division of the X10 magnified sweeps.	
Digital Sample Rate		
SAMPLE (5 /div to 5 s/div)	Single Trace 100 SEC/DIV Hz	CHOP/ALT 50 SEC/DIV Hz
PEAKDET or ACCPEAK (20 μ s/div to 5 s/div)	10 MHz (50% duty factor on each channel in CHOP)	
REPETITIVE Store		
0.05 μ s/div to 1 μ s/div	20 MHz	20 MHz
2 μ s/div	10 MHz	10 MHz.
External Clock		
Input Frequency	Up to 1 kHz.	
Digital Sample Rate	10 MHz in ACCPEAK and PEAKDET, otherwise it is equal to the input frequency.	
Store Rate	One data pair for every second falling edge.	
Duty Cycle	10% or greater (100 μ s minimum hold time).	
Ext Clock Logic Thresholds	TTL compatible.	
Maximum Safe Input Voltage	25 V (dc + peak ac) or 25 V p-p ac at 1 kHz or less.	
Input Resistance	10 k Ω $\pm 10\%$.	

^bThe X10 MAG control extends the maximum sweep speed to 5 ns per division.

^cThe X10 MAG control extends the maximum sweep speed to 5 ns per division. The 4K COMPRESS control multiplies the SEC/DIV by 4.

OPTIONS AND ACCESSORIES

INTRODUCTION

This part contains a general description of instrument options available at the time of publication of this manual. Also included is a complete list (with Tektronix part numbers) of standard accessories included with each instrument and a partial list of optional accessories. Additional information about instrument options, option availability, and other accessories can be obtained either by consulting the current Tektronix Products Catalog or by contacting your local Tektronix Field Office or representative.

STANDARD ACCESSORIES

The following standard accessories are provided with each instrument:

	Part Number
2 10X, P6121 Probe packages	010-6121-01
1 Power Cord	As Ordered
1 Operators Manual	070-4998-00
1 Users Reference Guide	070-5370-00
1 Front Panel Cover	200-2520-00
1 Accessory Pouch	016-0677-02
1 Fuse, 3AG, 2A, 250 V SLO-BLO	159-0023-00
1 DB-9 Female Connector	131-1007-00
1 DB-9 Connector Shell	200-3238-00
1 Loop Clamp	343-0003-00
1 Flat Washer	210-0803-00
1 Self-Tapping Screw	213-0882-00

OPTIONAL ACCESSORIES

The following optional accessories are recommended for use with the instrument:

	Part Number
Service Manual	070-4999-00
Probe Tips, with actuator (for P612X probes)	013-0191-00
Rack Adapter	016-1003-00
Viewing Hood	016-0566-00
Carrying Strap	346-0199-00
Carrying Case	016-0792-00
C5C Option 04 Camera	
K117 Instrument Shuttle	
K212 Portable Instrument Cart	

POWER CORD OPTIONS

Instruments are shipped with the detachable power-cord configuration ordered by the customer. Descriptive information about the international power-cord options is provided in Section 2, "Preparation for Use". The following list identifies the Tektronix part numbers for the available power cords:

Standard (United States)	161-0104-00
Option A1 (Universal Euro)	161-0104-06
Option A2 (United Kingdom)	161-0104-07
Option A3 (Australian)	161-0104-05
Option A4 (North American)	161-0104-08
Option A5 (Switzerland)	161-0167-00

Table 1-1 (cont)

Characteristics	Performance Requirements
STORE Mode Dynamic Range	10.24 divisions.
STORE Mode Resolution Acquisition Record Length	1024 or 4096 data points.
Single Waveform Acquisition Display	1024 data points (100 data points per division across the graticule area).
CHOP or ALT Acquisition Display	512 data points (50 data points per division across the graticule area).
Horizontal POSITION Control Range (NON STORE)	Start of the 10th division will position past the center vertical graticule line; 100th division in X10 magnified.
Horizontal Variable Sweep Control Range NON STORE	Continuously variable between calibrated settings of the SEC/DIV switch. Extends the A and the B Sweep speeds by at least a factor of 2.5 times over the calibrated SEC/DIV settings.
STORE	Horizontal Variable Sweep has no affect on the STORE Mode time base. Rotating the Variable SEC/DIV control out of the CAL detent position horizontally compresses a 4K point acquisition record to 1K points in length, so that the whole record length can be viewed on screen. Screen readout is altered accordingly.
Displayed Trace Length NON STORE	Greater than 10 divisions.
STORE	10.24 divisions.
Delay Time 0.5 μ s per division to 5 sec per division (A Sweep) Delay POSITION Range	Less than (0.5 div + 300 ns) to greater than 10 divisions. Delay Time is functional, but not calibrated, at A Sweep speeds faster than 0.5 μ s per division.
Delay Jitter	One part or less in 5,000 (0.02%) of the maximum available delay time.
Delay Time Differential Measurement Accuracy (for Runs After Delay and B Sweep Triggers only) +15°C to +35°C	$\pm 1\%$ of full scale.
0°C to +50°C	$\pm 2\%$ of full scale. Exclude delayed operation when the A and B SEC/DIV knobs are locked together at any sweep speed or when the A SEC/DIV switch setting is 0.5 μ s per division or faster. Accuracy applies over the B DELAY TIME POSITION control range.

Table 1-1 (cont)

Characteristics	Performance Requirements
DIGITAL STORAGE DISPLAY	
Vertical	
Resolution	10 bits (1 part in 1024). Display waveforms are calibrated for 100 data points per division.
Differential Accuracy	Graticule indication of the voltage cursor difference is within 2% of the readout value, measured over the center six divisions.
POSITION Range	Any portion of a stored waveform vertically magnified or compressed up to 10 times can be positioned to the top and to the bottom of the graticule area.
Position Registration NON STORE to STORE	Within ± 0.5 division at graticule center at VOLTS/DIV switch settings from 2 mV per division to 5 V per division.
Acquisition to SAVE REF	Within ± 0.2 division at VOLTS/DIV switch settings from 2 mV per division to 5 V per division.
SAVE Mode Expansion or Compression Range	Up to 10 times as determined by the remaining VOLTS/DIV switch positions up or down. 2 mV per division acquisitions cannot be expanded, and 5 V per division acquisitions cannot be compressed.
Storage Display Expansion Algorithm Error	$\pm 0.01\%$ of full scale.
Storage Display Compression Algorithm Error	+0.16% of reading $\pm 0.04\%$ of full scale.
Horizontal	
Resolution	10 bits (1 part in 1024). Calibrated for 100 data points per division.
Differential Accuracy	Graticule indication of time cursor difference is within $\pm 2\%$ of the readout value, measured over the center eight divisions.
SAVE Mode Expansion Range Y-T Mode	Up to 10 times as determined by the X10 MAG switch and the remaining SEC/DIV switch positions faster. 0.05 μ s/div acquisitions cannot be expanded.
X-Y Mode	In X-Y mode, Horizontal expansion and compression of the display is controlled by the CH 2 VOLTS/DIV switch in the same manner as Vertical expansion and compression.
Expansion Accuracy	Same as the Vertical.

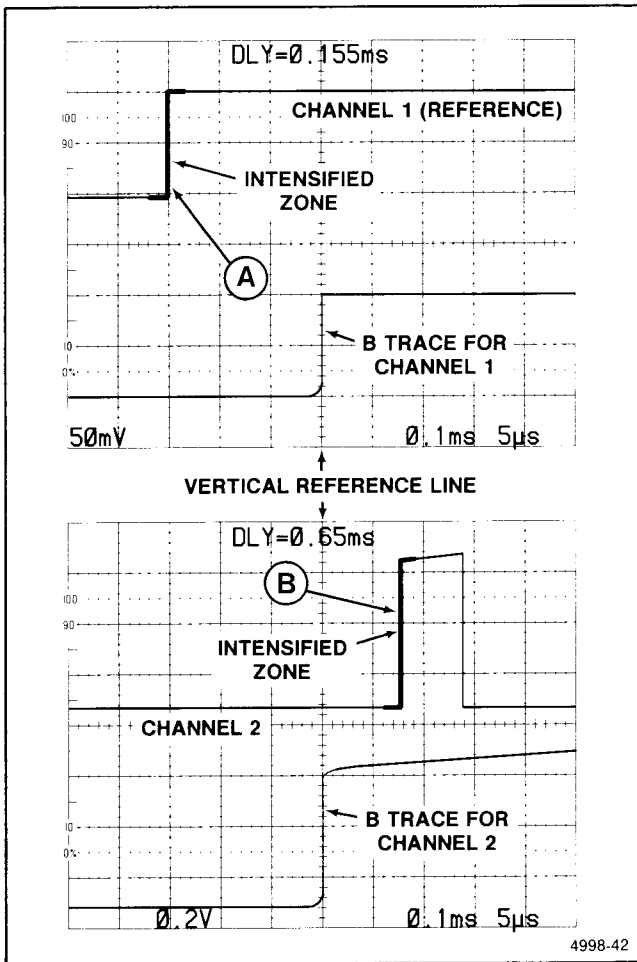

Figure 6-29. Time difference between two time-related pulses, differential time method.

7. Rotate the B DELAY TIME POSITION control to move the intensified zone to the rising edge of the reference pulse (on the A trace); then fine adjust until the rising portion (on the B trace) is centered at any convenient vertical graticule line (see Figure 6-29, Point A).

8. Record the DELAY TIME POSITION readout.

9. Select CH 2 VERTICAL MODE and adjust both the Channel 2 POSITION control and the A/B SWP SEP control as necessary to display the A trace above the B trace.

10. Rotate the B DELAY TIME POSITION control to set the rising portion of the Channel 2 pulse (on the B trace) to the same vertical reference point as used in step 7 (see Figure 6-29, Point B). Observe the A trace to position the intensified zone to the correct pulse (if more than one pulse is displayed). Do not change the setting of the Horizontal POSITION control.

11. Record the DELAY TIME POSITION readout.

12. Calculate the time difference between the Channel 1 and Channel 2 pulses as in the preceding "Time Difference Between Repetitive Pulses" measurement procedure.

Table 1-1 (cont)

Characteristics	Performance Requirements
DIGITAL READOUT DISPLAY	
CURSOR Accuracy Voltage Difference	Within $\pm 3\%$ of the ΔV readout value.
Time Difference RECORD, PEAKDET, AND SMOOTH Store	Within $\pm 0.1\%$ of the Δt readout value.
REPETITIVE Store	$\pm (0.1\% + 2 \text{ display intervals} + [2 \text{ display intervals if SMOOTHed}])$.
X-Y OPERATION (X1 MAGNIFICATION ONLY)	
Deflection Factors	Same as vertical deflection system with the VOLTS/DIV Variable controls in the CAL detent position.
NON STORE Accuracy X-Axis +15°C to +35°C	Measured with a dc-coupled, five-division reference signal. Within $\pm 3\%$.
0°C to +50°C	Within $\pm 4\%$.
Y-Axis	Same as vertical deflection system.
NON STORE Bandwidth (–3 dB) X-Axis	Measured with a five-division reference signal. DC to at least 3 MHz.
Y-Axis	Same as vertical deflection system.
NON STORE Phase Difference Between X-Axis and Y-Axis Amplifiers	± 3 degrees or less from dc to 150 kHz. Vertical Input Coupling set to DC.
STORE Accuracy X-Axis and Y-Axis	Same as digital storage vertical deflection system.
Useful Storage Bandwidth RECORD and REPETITIVE Store Modes	$\frac{5}{\text{SEC/DIV}}$ Hz
STORE Mode Time Difference Between Y-Axis and X-Axis Signals RECORD, SCAN, and ROLL Modes	100 ns. The X-Axis signal is sampled before the Y-Axis signal.
REPETITIVE Store	$\frac{\text{SEC/DIV}}{100} \times 4$

Basic Applications—2230 Operators

1. Preset instrument controls and obtain a baseline trace.

2. Apply a 5-division signal to either vertical-channel input connector and set the VERTICAL MODE switch to display the channel used. Ensure that the VOLTS/DIV Variable control is in the CAL detent.

NOTE

For rise times less than 0.2 μ s per division, the VOLTS/DIV Variable control may be used to obtain an exact 5-division display.

3. Vertically position the trace so that the zero reference of the waveform touches the 0% graticule line and the top of the waveform touches the 100% graticule line (see Figure 6-28).

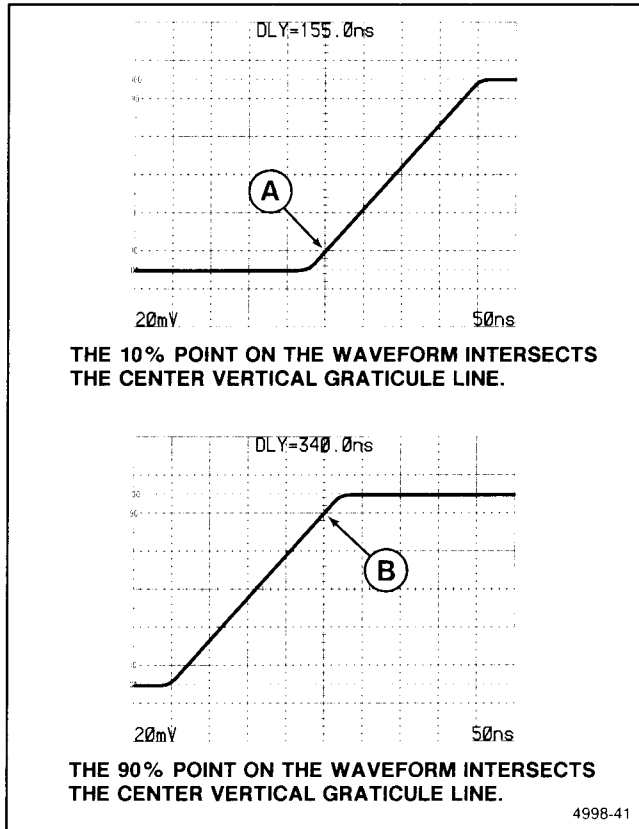

Figure 6-28. Rise time, differential time method.

4. Set the A SEC/DIV switch for a single-waveform display. Ensure that the A and B SEC/DIV Variable control is in the CAL detent.

5. Select BOTH HORIZONTAL MODE and set the B SEC/DIV switch to spread the rise-time-measurement portion of the display as much as possible.

6. Select the B HORIZONTAL MODE. Adjust the B DELAY TIME POSITION control until the display intersects the 10% point at the center vertical graticule line (see Figure 6-28, Point A).

7. Record the DELAY TIME POSITION readout.

8. Adjust the B DELAY TIME POSITION control until the display intersects the 90% point at the center vertical graticule line (see Figure 6-28, Point B).

9. Record the DELAY TIME POSITION readout.

10. Calculate rise time using the same formula listed in the "Time Difference Between Repetitive Pulses" measurement procedure.

Time Difference Between Two Time-Related Pulses

1. Preset instrument controls and obtain a baseline trace.

2. Using probes or cables having equal time delays, apply the reference signal to the Channel 1 input and apply the comparison signal to the Channel 2 input.



3. Set both VOLTS/DIV switches to produce a display of 2 to 3 divisions in amplitude.

4. Select BOTH VERTICAL MODE and either ALT or CHOP, depending on the frequency of the input signals.

5. Set the A SEC/DIV switch to display the measurement points of interest within the graticule area.

6. Select BOTH HORIZONTAL MODE and CH 1 VERTICAL MODE. Adjust both the Channel 1 POSITION control and the A/B SWP SEP control so that the A trace is displayed above the B trace.

Table 1-1 (cont)

Characteristics	Performance Requirements
PROBE ADJUST	
Output Voltage on PRB ADJ Jack	0.5 V \pm 5%.
Probe Adjust Signal Repetition Rate	1 kHz \pm 20%.
Z-AXIS	
Sensitivity (NON STORE Only)	5 V causes noticeable modulation. Positive-going input decreases intensity. Usable frequency range is dc to 20 MHz.
Maximum Input Voltage 	30 V (dc + peak ac) or 30 V p-p ac at 1 kHz or less.
Input Resistance	10 k Ω \pm 10%.
POWER SUPPLY	
Line Voltage Range	90 Vac to 250 Vac.
Line Frequency	48 Hz to 440 Hz.
Maximum Power Consumption	85 watts (150 VA).
Line Fuse	2 A, 250 V, slow blow.
Primary Circuit Dielectric Requirement	Routine test to 1500 Vrms, 60 Hz, for 10 seconds without breakdown.
CRT DISPLAY	
Display Area	8 cm x 10 cm.
Standard Phosphor	P31.
Nominal Accelerating Voltage	14 kV.
X-Y PLOTTER OUTPUT	
Maximum Safe Applied Voltage, Any Connector Pin 	25 V (dc + peak ac) or 25 V p-p ac at 1 kHz or less.
External Clock Input	
Rate	Up to 1 kHz.
Duty Cycle	10% or greater (100 μ s minimum pulse width).
Thresholds	TTL compatible.
Input Resistance	20 k Ω .
X and Y Plotter Outputs	
Pen Lift/Down	Fused relay contacts, 100 mA maximum.
Output Voltage Levels	500 mV per division \pm 5%. Center screen is 0 V \pm 0.2 division.
Series Resistance	2 k Ω \pm 10%.
4.2 V Output	4.2 V \pm 10% through 2 k Ω .

NOTE

The intensified zone seen in the ALT HORIZONTAL MODE display will move from trigger point to trigger point as the B DELAY TIME POSITION control is rotated.

2. Adjust the B TRIGGER LEVEL control so the intensified zone on the A trace is stable.
3. The apparent magnification factor can be calculated from the formula shown in step 8 of the "Magnified Sweep Runs After Delay" procedure.

DELAYED-SWEEP TIME MEASUREMENTS

Operating the instrument with HORIZONTAL MODE set to either ALT or B permits time measurements to be made with a greater degree of accuracy than attained with HORIZONTAL MODE set to A. The following procedures describe how these measurements are accomplished.

Time Difference Between Repetitive Pulses

1. Preset instrument controls and obtain a baseline trace.
2. Turn the Readout ON if it's not on already.
3. Apply the signal to either vertical-channel input connector and set the VERTICAL MODE switch to display the channel used.
4. Set the appropriate VOLTS/DIV switch to produce a display of approximately 2 or 3 divisions in amplitude.
5. Set the A SEC/DIV switch to display the measurement points of interest within the graticule area.
6. Select BOTH HORIZONTAL MODE and adjust both the appropriate channel POSITION control and A/B SWP SEP control to display the A trace above the B trace.
7. For the most accurate measurement, set the B SEC/DIV switch to the fastest sweep speed that provides a usable (visible) intensified zone.
8. Adjust the B DELAY TIME POSITION control to move the intensified zone to the leading edge of the first

pulse (on the A trace); then fine-adjust until the rising portion (on the B trace) is centered at any convenient vertical graticule line (see Figure 6-27).

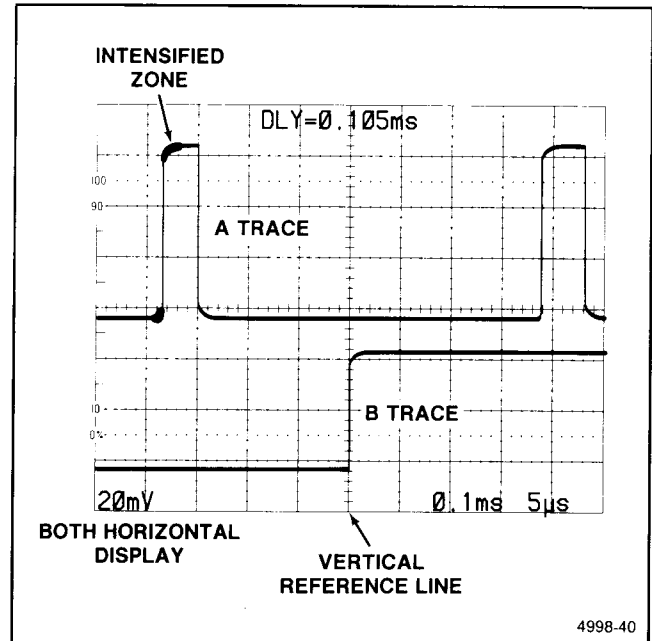

Figure 6-27. Time difference between repetitive pulses.

9. Record the DELAY TIME POSITION readout.
10. Adjust the B DELAY TIME POSITION control clockwise to move the intensified zone to the leading edge of the second pulse (on the A trace); then fine-adjust until the rising portion (on the B trace) is centered at the same vertical graticule used in step 7.
11. Record the DELAY TIME POSITION readout.
12. Calculate the time difference between repetitive pulses using the following formula:

$$\text{Time Difference (Duration)} = \frac{\text{Second Delay Time Readout}}{\text{First Delay Time Readout}}$$

Rise Time

The measurement method for rise time is the same as for time difference between repetitive pulses, except that the measurements are made between the 10% and 90% points on the leading edge of the waveform. Fall time is measured between the 90% and 10% points on the trailing edge of the waveform.

Table 1-2
Environmental Characteristics

Characteristics	Performance Requirements
Environmental Requirements	Instrument meets the requirements of Tektronix Standard 062-2853-00, Class 5, except EMI. The instrument meets the following MIL-T-28800C requirements for Type III, Class 5 equipment, except where noted otherwise.
Temperature	
Operating	0°C to +50°C (+32°F to +122°F).
Nonoperating	–55°C to +75°C (–67°F to +167°F). Tested to MIL-T-28800C, para 4.5.5.1.3 and 4.5.5.1.4, except that in para 4.5.5.1.3 steps 4 and 5 are performed before step 2 (–55°C nonoperating test). Equipment shall remain off upon return to room ambient temperature during step 6. Excessive condensation shall be removed before operating during step 7.
Altitude	
Operating	To 4,500 meters (15,000 feet). Maximum operating temperature decreases 1°C per 1,000 feet above 5,000 feet.
Nonoperating	To 15,000 meters (50,000 feet).
Humidity	
Operating and Nonoperating	5 cycles (120 hours) referenced to MIL-T-28800C para 4.5.5.1.2.2 for Type III, Class 5 instruments. Operating and nonoperating at 95%, –5% to +0%, relative humidity. Operating, +30°C to +50°C; nonoperating, +30°C to +60°C.
EMI (electromagnetic interference)	Meets radiated and conducted emission requirements per VDE 0871, Class B.
Vibration	
Operating	15 minutes along each of three major axes at a total displacement of 0.015 inch p-p (2.4 g at 55 Hz) with frequency varied from 10 Hz to 55 Hz to 10 Hz in one-minute sweeps. Hold for 10 minutes at 55 Hz in each of the three major axes. All major resonances are above 55 Hz.
Shock	
Operating and Nonoperating	30 g, half-sine, 11 ms duration, three shocks per axis each direction, for a total of 18 shocks.

Basic Applications—2230 Operators

TIME POSITION control. With either BOTH or B HORIZONTAL MODE selected, the B DELAY TIME POSITION control provides continuously variable positioning of the B Sweep. The range of this control is sufficient to place the B Sweep interval at any location within the A Sweep interval. When BOTH HORIZONTAL MODE is selected, the B SEC/DIV switch setting determines the B Sweep speed and concurrently sets the length of the intensified zone on the A trace.

Using delayed-sweep magnification may produce a display with some slight horizontal movement (pulse jitter). Pulse jitter includes not only the inherent uncertainty of triggering the delayed sweep at exactly the same trigger point each time, but also jitter that may be present in the input signal. If pulse jitter needs to be measured, use the "Pulse Jitter Time Measurement" procedure.

Magnified Sweep Runs After Delay

The following procedure explains how to operate the B Sweep in a nontriggered mode and to determine the resulting apparent magnification factor.

1. Preset instrument controls and obtain a baseline trace.

2. Apply the signal to either vertical channel input connector and set the VERTICAL MODE switch to display the channel used.

3. Set the appropriate VOLTS/DIV switch to produce a display of approximately 2 or 3 divisions in amplitude and center the display.

4. Set the A SEC/DIV switch to a sweep speed which displays at least one complete waveform cycle.

5. Select BOTH HORIZONTAL MODE. Adjust both the appropriate channel POSITION control and the A/B SWP SEP control to display the A trace above the B trace.

6. Adjust the B DELAY TIME POSITION control to position the start of the intensified zone to the portion of the display to be magnified (see Figure 6-26).

7. Set the B SEC/DIV switch to a setting which intensifies the full portion of the A trace to be magnified. The intensified zone will be displayed as the B trace (see Figure 6-26). The B HORIZONTAL MODE may also be used to magnify the intensified portion of the A Sweep.

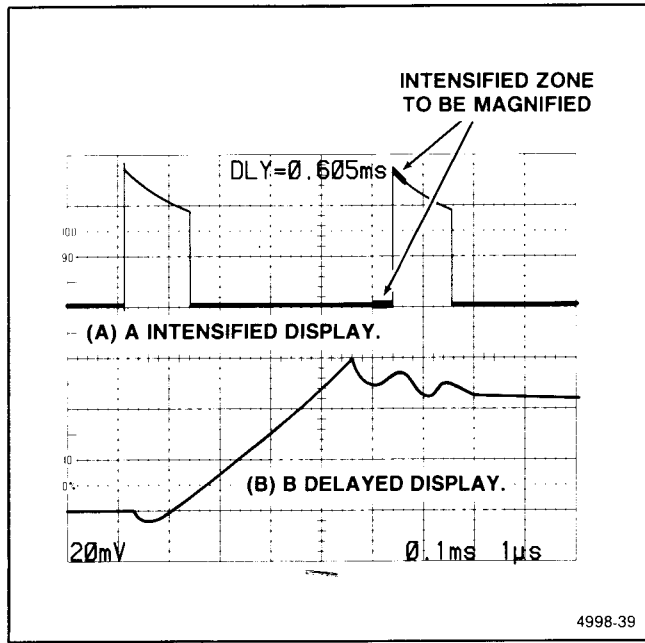

Figure 6-26. Delayed-sweep magnification.

8. The apparent sweep magnification can be calculated from the following formula:

$$\text{Apparent Delayed Sweep Magnification} = \frac{\text{A SEC/DIV switch setting}}{\text{B SEC/DIV switch setting}}$$

EXAMPLE: Determine the apparent magnification of a display with an A SEC/DIV switch setting of 0.1 ms and a B SEC/DIV switch setting of 1 μ s.

Substituting the given values:

$$\text{Apparent Magnification} = \frac{1 \times 10^{-4} \text{ s}}{1 \times 10^{-6} \text{ s}} = 10^2 = 100$$

Triggered Magnified Sweep

The following procedure explains how to operate the B Sweep in a triggered mode and to determine the resulting apparent magnification factor. Operating the B Sweep in a triggered mode provides a more stable display, since the delayed display is triggered at the same point each time.

1. Perform steps 1 through 7 of the preceding "Magnified Sweep Runs After Delay" procedure.

Table 1-3
Physical Characteristics

Characteristics	Description
Weight	See Figure 1-2 for dimensional drawing.
With Power Cord, Cover, Probes, and Pouch	9.4 kg (20.7 lb).
With Power Cord Only	8.2 kg (18 lb).
Domestic Shipping Weight	12.2 kg (26.9 lb).
Height	137 mm (5.4 in).
Width	
With Handle	362 mm (14.3 in).
Without Handle	327 mm (12.9 in).
Depth	
With Front Cover	445 mm (17.5 in).
Without Front Cover	435 mm (17.1 in).
With Handle Extended	510 mm (20.1 in).

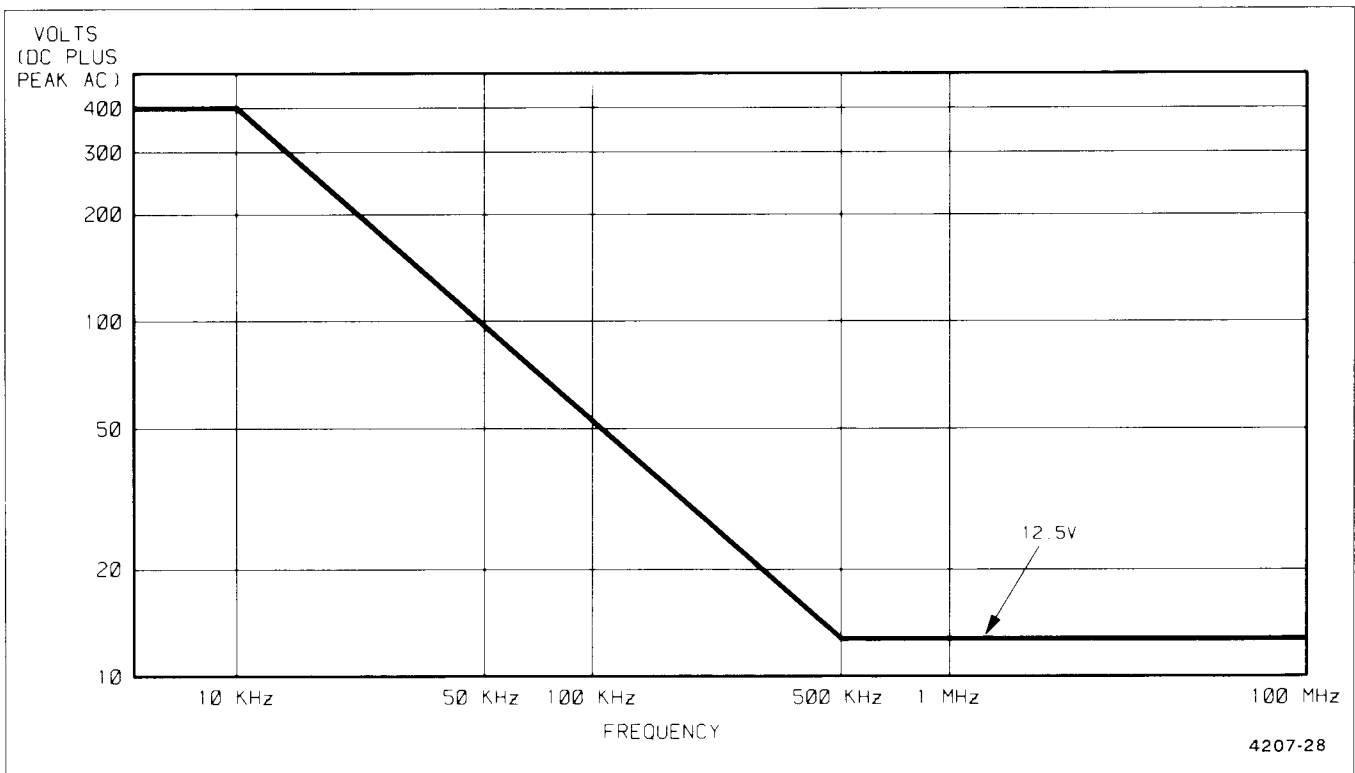

Figure 1-1. Maximum input voltage vs frequency derating curve for CH 1 OR X, CH 2 OR Y, and EXT INPUT connectors.

The frequency of the unknown signal is then calculated:

$$\text{Frequency} = \frac{1}{480 \mu\text{s}} = 2.083 \text{ kHz}$$

TV LINE SIGNAL

The following procedure is used to display a TV Line signal:

1. Preset instrument controls and select the A TRIGGER mode of P-P AUTO/TV LINE.
2. Apply the TV signal to either vertical-channel input connector and set the VERTICAL MODE switches to display the channel used.
3. Set the appropriate VOLTS/DIV switch to display 0.3 division or more of composite video signal.
4. Set the A SEC/DIV switch to 10 μs .
5. Set the A TRIGGER SLOPE switch to either OUT (for positive-going TV signal sync pulses) or IN (for negative-going TV signal sync pulses).

NOTE

To examine a TV Line signal in more detail, either the X10 Magnifier or the Delayed-Sweep Magnification feature may be used.

TV FIELD SIGNAL

The television feature of the instrument can also be used to display TV Field signals.

1. Preset instrument controls and obtain a baseline trace.
2. Set the A TRIGGER Mode switch to TV FIELD (P-P AUTO and NORM buttons both pushed in) and set the A SEC/DIV switch to 2 ms.
3. To display a single field, connect the TV signal to either vertical-channel input connector and set the VERTICAL MODE switch to display the channel used.

4. Set the appropriate VOLTS/DIV switch to display 2.5 divisions or more of composite video signal.
5. Set the A TRIGGER SLOPE switch to either OUT (for positive-going TV signal sync pulses) or IN (for negative-going TV signal sync pulses).

6. To change the field that is displayed, momentarily interrupt the trigger signal by setting the AC-GND-DC switch to GND and then back to AC until the desired field is displayed.

NOTE

To examine a TV Field signal in more detail, either the X10 Magnifier or the Delayed-Sweep Magnification feature may be used.

7. To display a selected horizontal line, first trigger the sweep on a vertical (field) sync pulse, then use the "Magnified Sweep Runs After Delay" procedure in this part (steps 5 through 7) to magnify the selected horizontal line for a closer examination. This procedure is useful for examining Vertical Interval Test Signals (VITS).

8. To display either Field 1 or Field 2 individually, connect the TV signal to both CH 1 and CH 2 input connectors and select BOTH and ALT VERTICAL MODE.

9. Set the A SEC/DIV switch to a faster sweep speed (displays of less than one full field). This will synchronize the Channel 1 display to one field and the Channel 2 display to the other field.

DELAYED-SWEEP MAGNIFICATION

The delayed-sweep feature of the instrument can be used to provide higher apparent magnification than is provided by the X10 Magnifier switch. Apparent magnification occurs as a result of displaying a selected portion of the A trace at a faster sweep speed (B Sweep speed). The A SEC/DIV switch setting determines how often the B trace will be displayed. Since the B Sweep can occur only once for each A Sweep, the A Sweep time duration sets the amount of elapsed time between succeeding B Sweeps.

The intensified zone is an indication of both the location and length of the B Sweep interval within the A Sweep interval. Positioning of the intensified zone (i.e., setting the amount of time between start of the A Sweep and the start of the B Sweep) is accomplished with the B DELAY

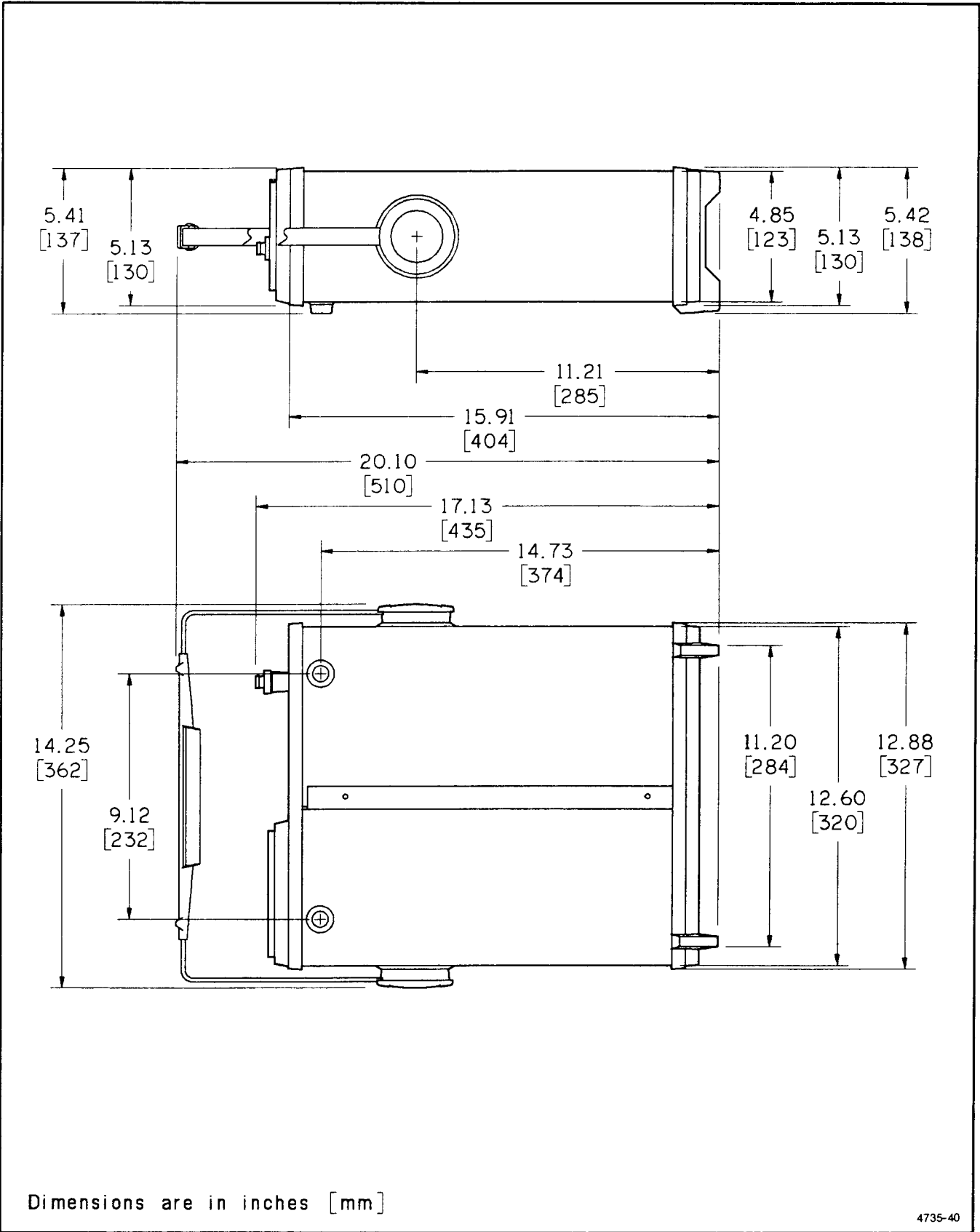

Dimensions are in inches [mm]

4735-40

Figure 1-2. Physical dimensions of the 2230 Oscilloscope.

Basic Applications—2230 Operators

Substituting the given values in the phase difference formula:

$$\text{Phase Difference} = 6 \text{ div} \times 4.5^\circ/\text{div} = 27^\circ$$

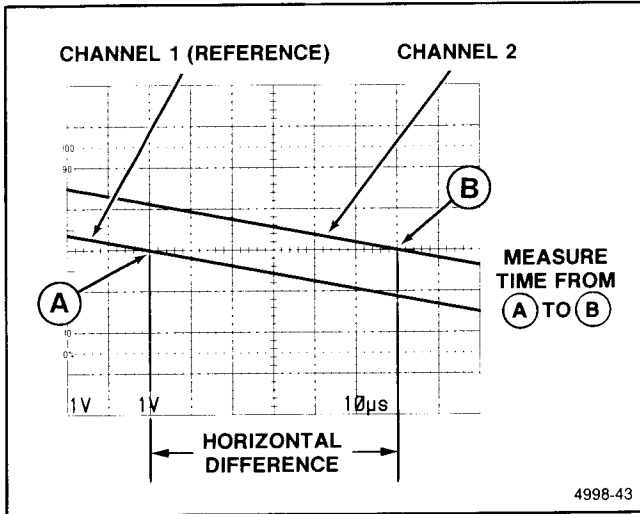

Figure 6-25. High-resolution phase difference.

TIME COMPARISON

In a similar manner to "Amplitude Comparison," repeated time comparisons between unknown signals and a reference signal (e.g., on assembly-line test) may be easily and accurately measured with the instrument. To accomplish this, a reference signal of known time duration is first set to an exact number of horizontal divisions by adjusting the A SEC/DIV switch and the SEC/DIV Variable control. Unknown signals can then be compared with the reference signal without disturbing the setting of the SEC/DIV Variable control. The procedure is as follows:

1. Set the time duration of the reference signal to an exact number of horizontal divisions by adjusting the A SEC/DIV switch and the SEC/DIV Variable control.
2. Establish a horizontal conversion factor, using the following formula (reference-signal time duration must be known):

$$\text{Horizontal Conversion Factor} = \frac{\text{reference signal time duration (seconds)}}{\text{horizontal distance (divisions)} \times \text{A SEC/DIV switch setting}}$$

3. For the unknown signal, adjust the A SEC/DIV switch to a setting that provides sufficient horizontal deflection to make an accurate measurement. Do not readjust the SEC/DIV Variable control.

4. Establish an arbitrary deflection factor, using the following formula:

$$\text{Arbitrary Deflection Factor} = \frac{\text{horizontal conversion}}{\text{conversion factor}} \times \frac{\text{A SEC/DIV switch setting}}{\text{switch setting}}$$

5. Measure the horizontal distance of the unknown signal in divisions and calculate its time duration using the following formula:

$$\text{Time Duration} = \frac{\text{arbitrary deflection factor}}{\text{deflection factor}} \times \frac{\text{horizontal distance (divisions)}}{\text{distance (divisions)}}$$

EXAMPLE: The reference signal time duration is 2.19 ms, the A SEC/DIV switch setting is 0.2 ms, and the SEC/DIV Variable control is adjusted to provide a horizontal distance of exactly 8 divisions.

Substituting the given values in the horizontal conversion factor formula:

$$\text{Horizontal Conversion Factor} = \frac{2.19 \text{ ms}}{8 \text{ div} \times 0.2 \text{ ms/div}} = 1.37$$

For the unknown signal the A SEC/DIV switch setting is 50 μs , and one complete cycle spans seven horizontal divisions. The arbitrary deflection factor is then determined by substituting values in the formula:

$$\text{Arbitrary Deflection Factor} = 1.37 \times 50 \mu\text{s/div} = 68.5 \mu\text{s/div}$$

The time duration of the unknown signal can then be computed by substituting values in the formula:

$$\text{Time Duration} = 68.5 \mu\text{s/div} \times 7 \text{ div} = 480 \mu\text{s}$$

PHASE DIFFERENCE

In a similar manner to "Time Difference", phase comparison between two signals of the same frequency can be made using the dual-trace feature of the instrument. This method of phase difference measurement can be used up to the frequency limit of the vertical system. To make a phase comparison, use the following procedure:

1. Preset instrument controls and obtain a baseline trace, then set the A TRIGGER A&B INT switch to CH 1.

2. Set both AC-GND-DC switches to the same position, depending on the type of input coupling desired.

3. Using either probes or coaxial cables with equal time delays, connect a known reference signal to the Channel 1 input and the unknown signal to the Channel 2 input.

4. Select BOTH VERTICAL MODE; then select either ALT or CHOP, depending on the frequency of the input signals. The reference signal should precede the comparison signal in time.

5. If the two signals are of opposite polarity, press in the Channel 2 INVERT button to invert the Channel 2 display.

6. Set both VOLTS/DIV switches and both Variable controls so the displays are equal in amplitude.

7. Adjust the A TRIGGER LEVEL control for a stable display.

8. Set the A SEC/DIV switch to a sweep speed which displays about one full cycle of the waveforms.

9. Position the displays and adjust the SEC/DIV Variable control so that one reference-signal cycle occupies exactly eight horizontal graticule divisions at the 50% rise-time points (see Figure 6-24). Each division of the graticule now represents 45° of the cycle ($360^\circ \div 8$ divisions), and the horizontal graticule calibration can be stated as 45° per division.

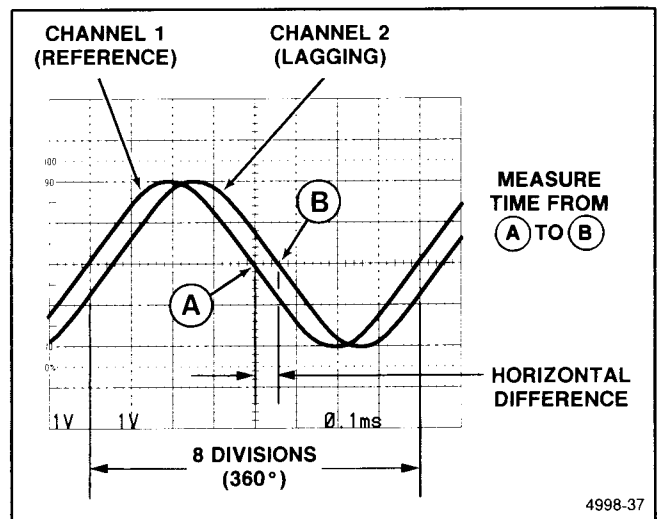

Figure 6-24. Phase difference.

10. Measure the horizontal difference between corresponding points on the waveforms at a common horizontal graticule line (50% of rise time) and calculate the phase difference using the following formula:

$$\text{Phase Difference} = \frac{\text{horizontal difference (divisions)}}{\text{horizontal graticule calibration } (^\circ/\text{div})} \times \text{horizontal graticule calibration } (^\circ/\text{div})$$

EXAMPLE: The horizontal difference is 0.6 division with a graticule calibration of 45° per division as shown in Figure 6-24.

Substituting the given values into the phase difference formula:

$$\text{Phase Difference} = 0.6 \text{ div} \times 45^\circ/\text{div} = 27^\circ$$

More accurate phase measurements can be made by using the X10 Magnifier function to increase the sweep speed without changing the SEC/DIV Variable control setting.

EXAMPLE: If the sweep speed were increased 10 times with the magnifier (X10 Magnifier out), the magnified horizontal graticule calibration would be $45^\circ/\text{division}$ divided by 10 (or $4.5^\circ/\text{division}$). Figure 6-25 shows the same signals illustrated in Figure 6-24, but magnifying the displays results in a horizontal difference of 6 divisions between the two signals.

PREPARATION FOR USE

SAFETY

This part of the manual tells how to prepare for and to proceed with the initial start-up of the instrument.

Refer to the Safety Summary at the front of this manual for power source, grounding, and other safety considerations pertaining to the use of the instrument. Before connecting the oscilloscope to a power source, read entirely both this section and the Safety Summary.

LINE VOLTAGE

This instrument is capable of continuous operation with input voltages that range from 90 V to 250 V with source voltage frequencies from 48 Hz to 440 Hz.

POWER CORD

A detachable three-wire power cord with a three-contact plug is provided with each instrument for connecting to both the power source and protective ground. The power cord may be secured to the rear panel by a cord-set-securing clamp (see Figure 2-1). The protective-ground contact in the plug connects (through the protective-ground conductor) to the accessible metal parts of the instrument. For electrical-shock protection, insert this plug only into a power-source outlet that has a properly grounded protective-ground contact.

Instruments are shipped with the power cord specified by the customer. Available power-cord information is presented in Figure 2-2, and part numbers are listed in "Options and Accessories" (Section 7). Contact your Tektronix representative or local Tektronix Field Office for additional power-cord information.

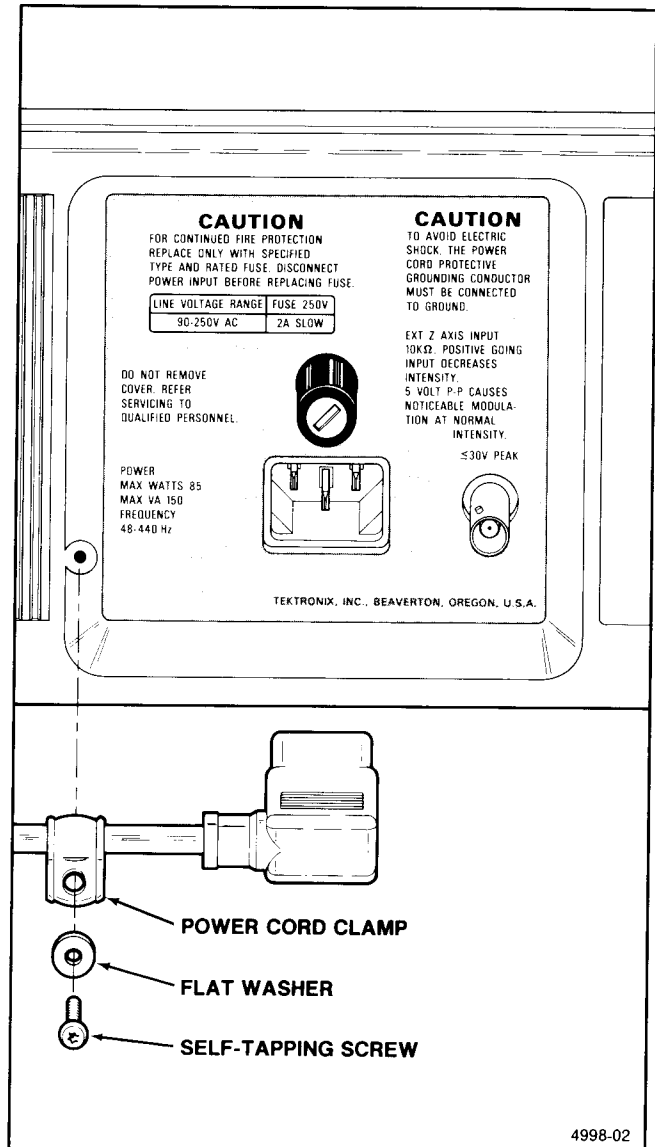

Figure 2-1. Securing the detachable power-cord to the instrument.

Basic Applications—2230 Operators

$$\text{Rise Time} = \frac{\text{horizontal distance (divisions)} \times \text{A SEC/DIV switch setting}}{\text{magnification factor}}$$

EXAMPLE: The horizontal distance between the 10% and 90% points is 5 divisions (see Figure 6-22), and the A SEC/DIV switch is set to 1 μs . The X10 magnifier knob is pushed in (1X magnification).

Substituting the given values in the formula:

$$\text{Rise Time} = \frac{5 \text{ div} \times 1 \mu\text{s/div}}{1} = 5 \mu\text{s}$$

TIME DIFFERENCE BETWEEN TWO TIME-RELATED PULSES

The calibrated sweep speed and dual-trace features of the instrument allow measurement of the time difference between two separate events. To measure time difference, use the following procedure:

1. Preset instrument controls and obtain a baseline trace.
2. Set the A TRIGGER A&B INT switch to CH 1.
3. Set both AC-GND-DC switches to the same position, depending on the type of input coupling desired.
4. Using either probes or cables with equal time delays, connect a known reference signal to the Channel 1 input and the comparison signal to the Channel 2 input.
5. Set both VOLTS/DIV switches for 4- or 5-division displays.
6. Select BOTH VERTICAL MODE; then select either ALT or CHOP, depending on the frequency of the input signals.
7. Adjust the A TRIGGER LEVEL control for a stable display.

8. Set the A SEC/DIV switch to a sweep speed which provides three or more divisions of horizontal separation between the reference points on the two displays. Center each of the displays vertically (see Figure 6-23).

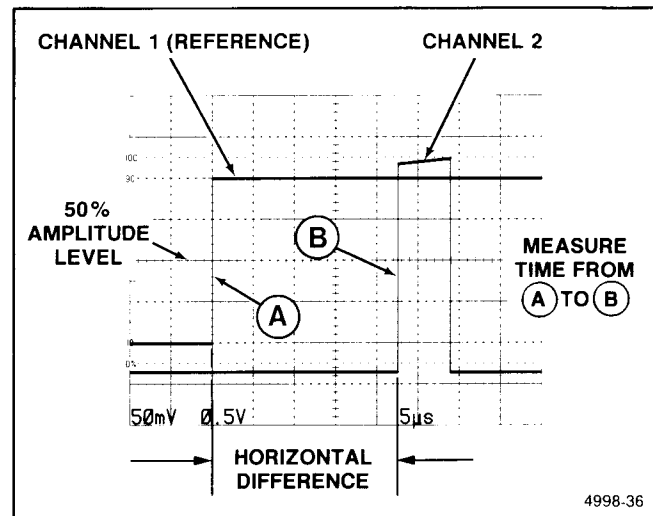

Figure 6-23. Time difference between two time-related pulses.

9. Measure the horizontal difference between the two signal-reference points and calculate the time difference using the following formula:





$$\text{Time Difference} = \frac{\text{A SEC/DIV switch setting} \times \text{horizontal difference (divisions)}}{\text{magnification factor}}$$

EXAMPLE: The A SEC/DIV switch is set to 50 μs , the X10 magnifier knob is pulled out, and the horizontal difference between waveform measurement points is 4.5 divisions.

Substituting the given values in the formula:

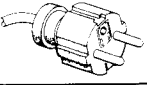
$$\text{Time Difference} = \frac{50 \mu\text{s/div} \times 4.5 \text{ div}}{10} = 22.5 \mu\text{s}$$

Preparation for Use—2230 Operators

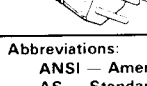
Plug Configuration	Usage	Line Voltage	Reference Standards
	North American 120V/ 15A	120V	ANSI C73.11 NEMA 5-15-P IEC 83
	Universal Euro 240V/ 10-16A	240V	CEE (7).II,IV,VII IEC 83
	UK 240V/ 13A	240V	BS 1363 IEC 83
	Australian 240V/ 10A	240V	AS C112
	North American 240V/ 15A	240V	ANSI C73.20 NEMA 6-15-P IEC 83
	Switzerland 220V/ 6A	220V	SEV
Abbreviations: ANSI — American National Standards Institute AS — Standards Association of Australia BS — British Standards Institution CEE — International Commission on Rules for the Approval of Electrical Equipment IEC — International Electrotechnical Commission NEMA — National Electrical Manufacturer's Association SEV — Schweizerischer Elektrotechnischer Verein			

(2931-21)4204-53

Figure 2-2. Optional power-cord data.

LINE FUSE

The instrument fuse holder is located on the rear panel (see Figure 2-3) and contains the line-protection fuse. The following procedure may be used either to verify that the proper fuse is installed or to install a replacement fuse.

1. Unplug the power cord from the power-input source (if plugged in).
2. Press in the fuse-holder cap and release it with a slight counterclockwise rotation.
3. Pull the cap (with the attached fuse inside) out of the fuse holder.
4. Verify that the proper fuse is installed (see the rear-panel fuse nomenclature).

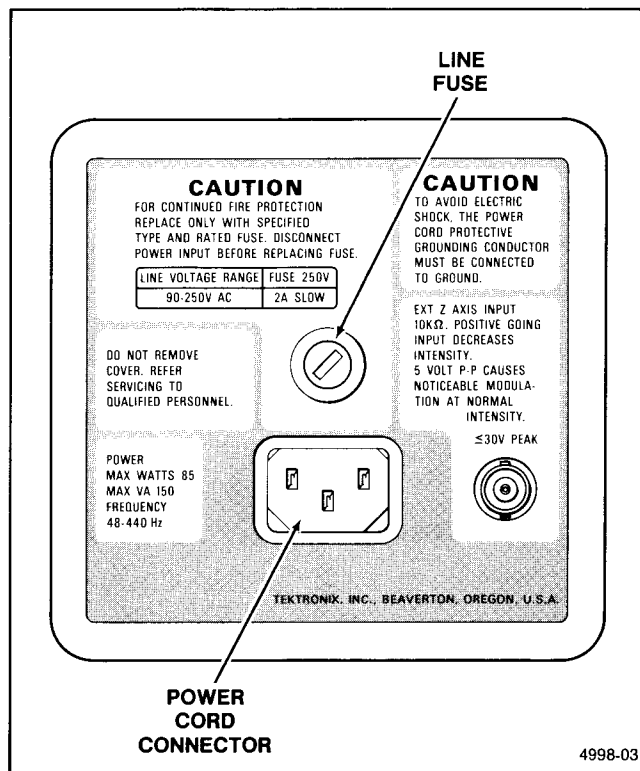

4998-03

Figure 2-3. Fuse holder and detachable power-cord connector.

5. Reinstall the proper fuse in the fuse cap and replace the cap and fuse in the fuse holder by pressing in and giving a slight clockwise rotation of the cap.

INSTRUMENT COOLING

To prevent instrument damage from overheated components, adequate internal airflow must be maintained at all times. Before turning on the power, first verify that both the fan-exhaust holes on the rear panel and the air-intake holes on the side panel are free from any obstructions to airflow. After turning on the instrument, verify that the fan is exhausting air.

START-UP

The instrument automatically performs power-up tests of the digital portion of the circuitry each time the instrument is turned on. The purpose of these tests is to provide the user with the highest possible confidence level that the instrument is fully functional. If no faults are encountered during the power-up testing, the instrument will enter the

five vertical divisions. The arbitrary deflection factor is then determined by substituting values in the formula:

$$\begin{aligned} \text{Arbitrary} \\ \text{Deflection} &= 1.5 \times 1 \text{ V/div} = 1.5 \text{ V/div} \\ \text{Factor} \end{aligned}$$

The amplitude of the unknown signal can then be determined by substituting values in the unknown signal amplitude formula:

$$\text{Amplitude} = 1.5 \text{ V/div} \times 5 \text{ div} = 7.5 \text{ V}$$

FREQUENCY

The frequency of a recurrent signal can be determined from its time-duration measurement as follows:

1. Measure the time duration of one waveform cycle using the preceding "Time Duration" measurement procedure.

2. Calculate the reciprocal of the time-duration value to determine the frequency of the waveform.

EXAMPLE: The signal in Figure 6-21 has a time duration of 16.6 ms.

Calculating the reciprocal of time duration:

$$\text{Frequency} = \frac{1}{\text{time duration}} = \frac{1}{16.6 \text{ ms}} = 60 \text{ Hz}$$

RISE TIME

Rise-time measurements use the same methods as time duration, except that the measurements are made between the 10% and 90% points on the leading edge of the waveform (see Figure 6-22). Fall time is measured between the 90% and 10% points on the trailing edge of the waveform.

1. Preset instrument controls and obtain a baseline trace.

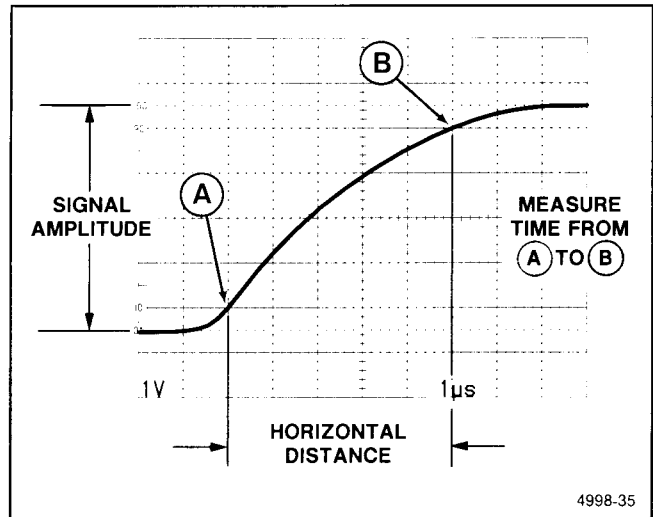

Figure 6-22. Rise time.

2. Apply an exact 5-division signal to either vertical-channel input connector and set the VERTICAL MODE switches to display the channel used. Ensure that the VOLTS/DIV Variable control is in the CAL detent.

NOTE

For rise time greater than 0.2 μ s, the VOLTS DIV Variable control may be used to obtain an exact 5-division display.

3. Set the A TRIGGER SLOPE switch to OUT (plus). Use a sweep-speed setting that displays several complete cycles or events (if possible).

4. Adjust vertical positioning so that the zero reference of the waveform touches the 0% graticule line and the top of the waveform touches the 100% graticule line (see Figure 6-22).

5. Set the A SEC/DIV switch for a single-waveform display, with the rise time spread horizontally as much as possible.

6. Horizontally position the display so the 10% point on the waveform intersects the second vertical graticule line (see Figure 6-22, Point A).

7. Measure the horizontal distance between the 10% and 90% points and calculate the time duration using the following formula:

normal operating mode. If the instrument fails one of the power-up tests, the instrument attempts to indicate the cause of the failure.

If a failure of any power-up test occurs, the instrument may still be useable for some applications, depending on the nature of the failure. If the instrument functions for your immediate measurement requirement, it may be used, but refer it to a qualified service technician for repair of the problem at the earliest convenience. Consult your service department, your local Tektronix Service Center, or your nearest Tektronix representative if additional assistance is required.

REPACKAGING

If this instrument is shipped by commercial transportation, use the original packaging material. Unpack the instrument carefully from the shipping container to save the carton and packaging material for this purpose.

If the original packaging is unfit for use or is not available, repackage the instrument as follows:

1. Obtain a corrugated cardboard shipping carton having inside dimensions at least six inches greater than the instrument dimensions and having a carton test strength of at least 275 pounds.
2. If the instrument is being shipped to a Tektronix Service Center for repair or calibration, attach a tag to the instrument showing the following: owner of the instrument (with address), the name of a person at your firm who may be contacted if additional information is needed, complete instrument type and serial number, and a description of the service required.
3. Wrap the instrument with polyethylene sheeting or equivalent to protect the outside finish and prevent entry of packing materials into the instrument.
4. Cushion the instrument on all sides by tightly packing dunnage or urethane foam between the carton and the instrument, allowing for three inches of padding on each side (including top and bottom).
5. Seal the carton with shipping tape or with an industrial stapler.
6. Mark the address of the Tektronix Service Center and your return address on the carton in one or more prominent locations.

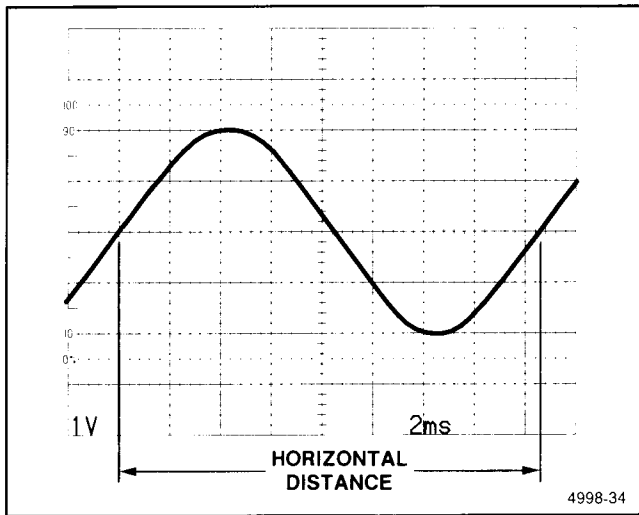

Figure 6-21. Time duration.

EXAMPLE: The distance between the time-measurement points is 8.3 divisions (see Figure 6-21), and the A SEC/DIV switch is set to 2 ms. The X10 Magnifier switch is pushed in (1X magnification).

Substituting the given values:

$$\text{Time Duration} = 8.3 \text{ div} \times 2 \text{ ms/div} = 16.6 \text{ ms}$$

AMPLITUDE COMPARISON

In some applications it may be necessary to establish a set of deflection factors other than those indicated by the VOLTS/DIV switch settings. This is useful for comparing unknown signals to a reference signal of known amplitude. To accomplish this, a reference signal of known amplitude is first set to an exact number of vertical divisions by adjusting the VOLTS/DIV switch and Variable control. Unknown signals can then be quickly and accurately compared with the reference signal without disturbing the setting of the VOLTS/DIV Variable control. The procedure is as follows.

1. Preset instrument controls and obtain a baseline trace.

2. Apply the reference signal to either vertical channel input and set the VERTICAL MODE switch to display the channel used.

3. Set the amplitude of the reference signal to an exact number of vertical divisions by adjusting the VOLTS/DIV switch and VOLTS/DIV Variable control.

4. Establish a vertical conversion factor, using the following formula (reference signal amplitude must be known):

$$\text{Vertical Conversion Factor} = \frac{\text{reference signal amplitude (volts)}}{\text{vertical deflection (divisions)} \times \text{VOLTS/DIV switch setting}}$$

5. Disconnect the reference signal and apply the unknown signal to be measured to the same channel input. Adjust the VOLTS/DIV switch to a setting that provides sufficient vertical deflection to make an accurate measurement. Do not readjust the VOLTS/DIV Variable control.

6. Establish an arbitrary deflection factor, using the following formula:

$$\text{Arbitrary Deflection Factor} = \frac{\text{vertical conversion}}{\text{conversion}} \times \frac{\text{VOLTS/DIV switch setting}}{\text{switch setting}}$$

7. Measure the vertical deflection of the unknown signal in divisions and calculate its amplitude using the following formula:

$$\text{Unknown Signal Amplitude} = \frac{\text{arbitrary deflection}}{\text{deflection}} \times \frac{\text{vertical deflection (divisions)}}{\text{deflection}}$$

EXAMPLE: The reference signal amplitude is 30 V, with a VOLTS/DIV switch setting of 5 V and the VOLTS/DIV Variable control adjusted to provide a vertical deflection of exactly 4 divisions.

Substituting these values in the vertical conversion factor formula:

$$\text{Vertical Conversion Factor} = \frac{30 \text{ V}}{4 \text{ div} \times 5 \text{ V/div}} = 1.5$$

Continuing, for the unknown signal the VOLTS/DIV switch setting is 1 and the peak-to-peak amplitude spans

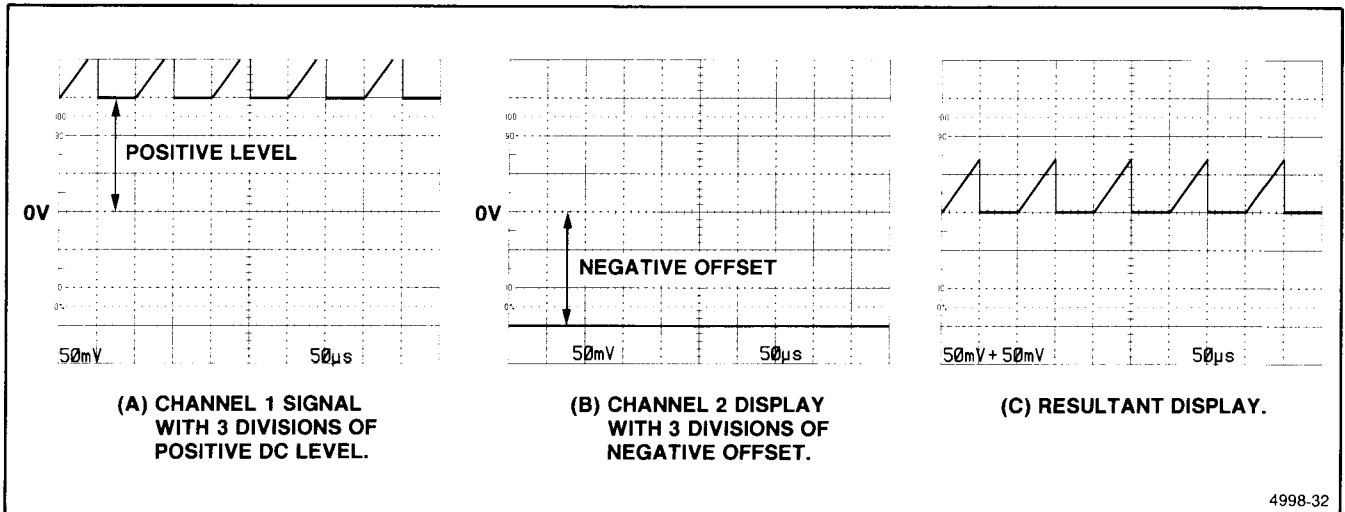

Figure 6-19. Algebraic addition.

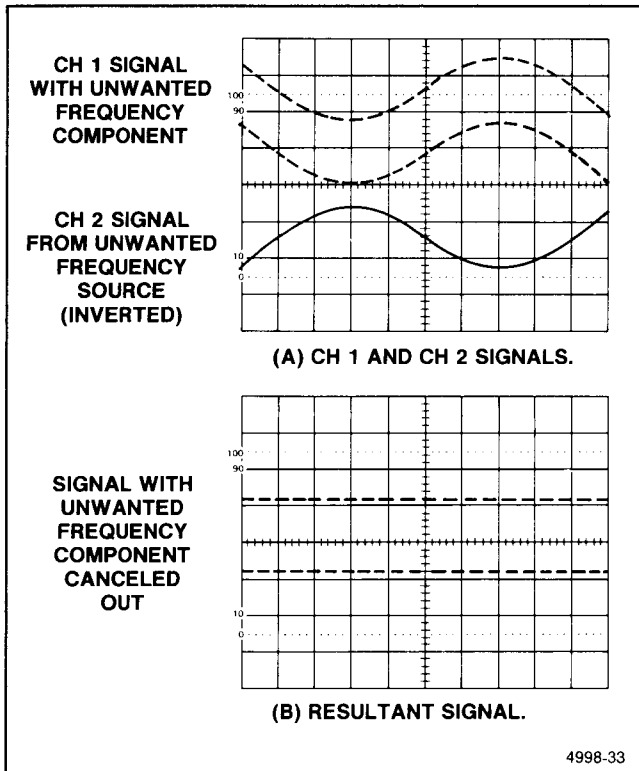

Figure 6-20. Common-mode rejection.

6. Select ADD VERTICAL MODE and slightly readjust the Channel 2 VOLTS/DIV Variable control for maximum cancellation of the undesired signal component (see Figure 6-20B).

TIME DURATION

To measure time between two points on a waveform, use the following procedure:

1. Preset instrument controls and obtain a baseline trace.
2. Apply the signal to either vertical-channel input connector and set the VERTICAL MODE switches to display the channel used.
3. Adjust the A TRIGGER LEVEL control to obtain a stable display.
4. Set the A SEC/DIV control to display one complete period of the waveform. Ensure that the A and B SEC/DIV Variable control is in the CAL detent.
5. Position the display to place the time-measurement points on the center horizontal graticule line (see Figure 6-21).
6. Measure the horizontal distance between the time-measurement points.

7. Calculate time duration, using the following formula:

$$\text{Time Duration} = \frac{\text{horizontal distance (divisions)} \times \text{A SEC/DIV switch setting}}{\text{magnification factor}}$$

CONTROLS, CONNECTORS, AND INDICATORS

The following descriptions are intended to familiarize the operator with the location and function of the instrument's controls, connectors, and indicators.

POWER AND DISPLAY

Refer to Figure 3-1 for location of items 1 through 9.

- 1 **Internal Graticule**—Eliminates parallax viewing error between the trace and the graticule lines. Rise-time amplitude and measurement points are indicated at the left edge of the graticule.
- 2 **POWER Switch**—Turns instrument power on or off. Press in for ON; press again for OFF.
- 3 **Power On Indicator**—Lights up while instrument is operating.
- 4 **FOCUS Control**—Adjusts for optimum display definition. Once set, proper focusing is maintained over a wide range of display intensity.
- 5 **STORAGE/READOUT INTENSITY Control**—Adjusts the brightness of the STORE mode displayed waveforms and the readout intensity in both STORE and NON STORE mode. The fully counterclockwise position of the control toggles the STORE/NON STORE readout on and off.
- 6 **BEAM FIND Switch**—Compresses the vertical and horizontal deflection to within the graticule area and intensifies the display to aid in locating traces that are overscanned or deflected outside of the crt viewing area.
- 7 **TRACE ROTATION Control**—Permits alignment of the trace with the horizontal graticule line. This control is a screwdriver adjustment that, once set, should require little attention during normal operation.

- 8 **A INTENSITY Control**—Adjusts the brightness of all NON STORE displayed waveforms. The control has no effect on the STORE mode displays or the crt readouts.

- 9 **B INTENSITY Control**—Adjusts the brightness of the NON STORE B Delayed Sweep and the Intensified zone on the A Sweep. The control has no effect on STORE mode displays or crt readouts.

VERTICAL

Refer to Figure 3-2 for location of items 10 through 19.

- 10 **VOLTS/DIV Switches**—Select the vertical channel deflection factors from 2 mV to 5 V per division in a 1-2-5 sequence. The VOLTS/DIV switch setting for both channels is displayed in the crt readout. The VOLTS/DIV control settings for displayed waveforms containing cursor symbols are shown in the crt readout.

In STORE mode, SAVE waveforms and waveforms waiting to be updated between trigger events may be vertically expanded or compressed by up to a factor of 10 times (or as many VOLTS/DIV switch positions remaining—whichever is less) by switching the corresponding VOLTS/DIV control (waveforms acquired at 2 mV/div cannot be expanded and waveforms acquired at 5 V/div cannot be compressed). The VOLTS/DIV readout reflects the vertical scale factor of the displayed waveform. If the VOLTS/DIV switch is switched beyond the available expansion or compression range, the readout is tilted to indicate that the VOLTS/DIV switch setting and the VOLTS/DIV readout no longer agree.

1X PROBE—Front-panel marking that indicates the deflection factor set by the VOLTS/DIV switch when a X1 probe or a coaxial cable is attached to the channel input connector.

10X PROBE—Front-panel marking that indicates the deflection factor set by the VOLTS/DIV switch when a properly coded 10X probe is attached to the channel input connector.

Basic Applications—2230 Operators

EXAMPLE: The vertical distance measured is 4.6 divisions (see Figure 6-18). The waveform is above the reference line, the VOLTS/DIV switch is set to 2 V, and a 10X scale-factor-switching probe is used.

Substituting the given values into the formula:

$$\text{Voltage} = 4.6 \text{ div} \times (+1) \times 2 \text{ V/div} = +9.2 \text{ V}$$

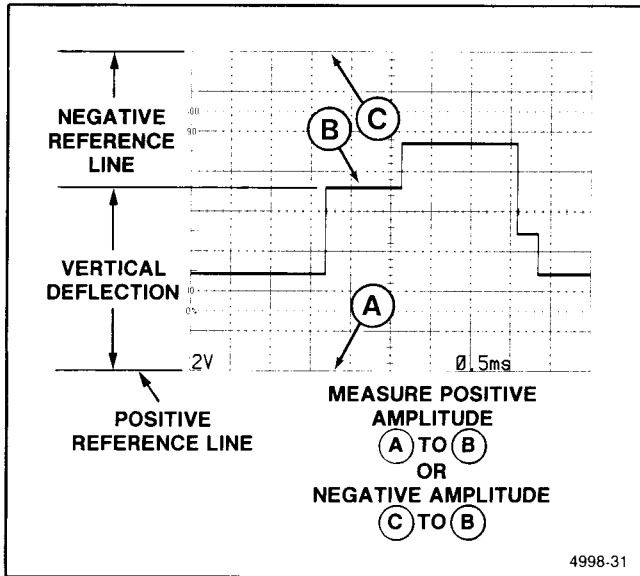

Figure 6-18. Ground referenced voltage measurement.

ALGEBRAIC ADDITION

With the VERTICAL MODE switches in the ADD position, the waveform displayed represents the algebraic sum of the signals applied to the Channel 1 and Channel 2 input connectors (CH 1 + CH 2). If the Channel 2 INVERT switch is pressed in, the resulting waveform is the difference of the signals applied to the Channel 1 and Channel 2 input connectors (CH 1 - CH 2). The total deflection factor in the ADD mode is equal to the deflection factor indicated by either VOLTS/DIV switch (when both VOLTS/DIV switches are set to the same deflection factor). A common use for the ADD mode is to provide a dc offset for a signal riding on top of a dc level.

The following general precautions should be observed when using the ADD mode:

- a. Do not exceed the input voltage rating of the oscilloscope.

- b. Do not apply signals that exceed the equivalent of about eight times the VOLTS/DIV switch setting, since large voltages may distort the display. For example, with a VOLTS/DIV switch setting of 0.5 V, the voltage applied to that channel input should not exceed about 4 volts.

EXAMPLE: Using the graticule center line as 0 V, the Channel 1 signal is at a 3-division, positive dc level (see Figure 6-19A).

1. Multiply 3 divisions by the VOLTS/DIV switch setting to determine the dc-level value.

2. To the Channel 2 input connector, apply a negative dc level (or positive level, using the Channel 2 INVERT switch) whose value was determined in step 1 (see Figure 6-19B).

3. Select ADD and BOTH VERTICAL MODE to place the resultant display within the operating range of the Vertical POSITION controls (see Figure 6-19C).

COMMON-MODE REJECTION

The ADD mode can also be used to display signals that contain undesirable frequency components. The undesirable components can be eliminated through common-mode rejection. The precautions given under the preceding "Algebraic Addition" procedure should be observed.

EXAMPLE: The signal applied to the Channel 1 input connector contains unwanted frequency components (see Figure 6-20A). To remove the undesired components, use the following procedure:

1. Preset instrument controls and obtain a baseline trace.
2. Apply the signal containing the unwanted components to the Channel 1 input.
3. Apply the unwanted signal to the Channel 2 input.
4. Select BOTH and ALT VERTICAL MODE and press in the Channel 2 INVERT button.
5. Adjust the Channel 2 VOLTS/DIV switch and Variable control so the Channel 2 display is approximately the same amplitude as the undesired portion of the Channel 1 display (see Figure 6-20A).

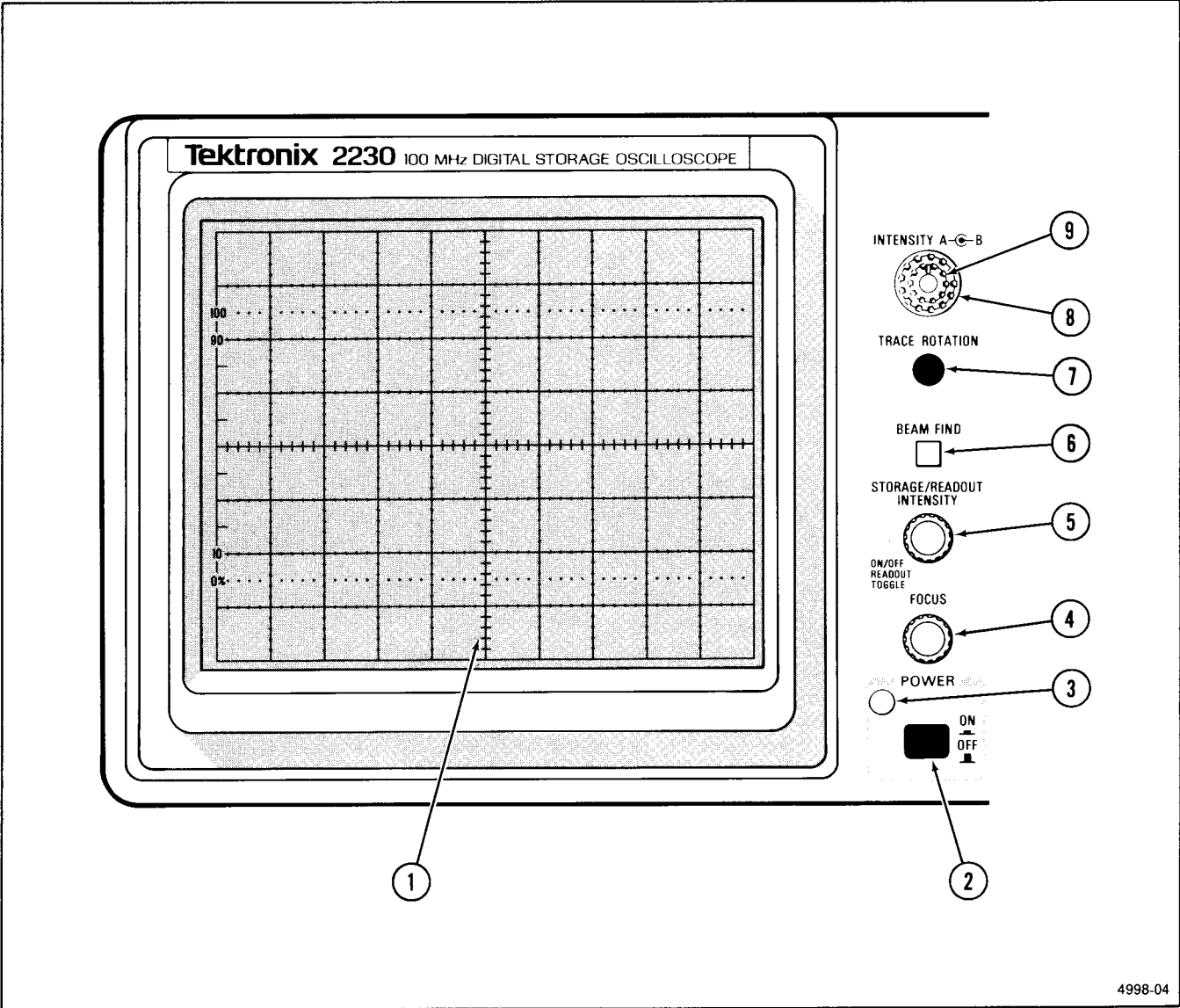

Figure 3-1. Power and display controls and power-on indicator.

GROUND REFERENCED DC VOLTAGE

NOTE

Either channel input connector may be used for the signal input. Use the VERTICAL MODE switches to select the appropriate channel for display.

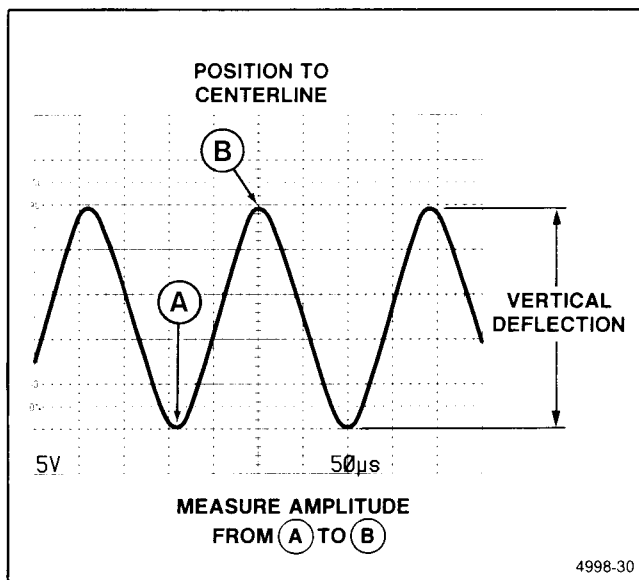

Figure 6-17. Peak-to-peak waveform voltage.

8. Measure the vertical deflection from peak to peak (see Figure 6-17, Point A to Point B).

NOTE

A more accurate value can be obtained by measuring from the top of a peak to the top of a valley. This eliminates trace thickness from the measurement.

9. Calculate the peak-to-peak voltage, using the following formula:

$$\text{Volts (p-p)} = \text{vertical deflection (divisions)} \times \text{VOLTS/DIV switch setting} \times \text{probe attenuation factor}$$

EXAMPLE: The measured peak-to-peak vertical deflection is 5 divisions (see Figure 6-17) with a VOLTS/DIV switch setting of 0.5 V, using a 10X probe.

Substituting the given values:

$$\text{Volts (p-p)} = 5 \text{ div} \times 0.5 \text{ V/div} \times 10 = 25 \text{ V}$$

1. Apply the signal to be measured to the selected channel input and obtain a NON STORE display.

2. Ensure that the VOLTS/DIV Variable control is in the calibrated detent and determine the polarity of the voltage to be measured as follows:

a. Set the AC-GND-DC switch to GND and vertically position the baseline trace to the center horizontal graticule line.

b. Set the AC-GND-DC switch to DC. If the waveform moves above the center line of the crt, the voltage is positive. If the waveform moves below the center line of the crt, the voltage is negative.

3. Set the AC-GND-DC switch to GND and position the baseline trace to a convenient reference line. For example, if the voltage to be measured is positive, position the baseline trace to the bottom graticule line. If a negative voltage is to be measured, position the baseline trace to the top graticule line.

4. Set the AC-GND-DC switch to DC. Measure the divisions of vertical deflection between the reference line and the desired point on the waveform (see Figure 6-18).

5. Calculate the voltage, using the following formula:

$$\text{Voltage} = \text{Vertical distance (divisions)} \times \text{Polarity (+ or -)} \times \text{VOLTS/DIV switch setting}$$

NOTE

The attenuation factor of the probe being used must be included if it is not a 10X scale-factor-switching probe.

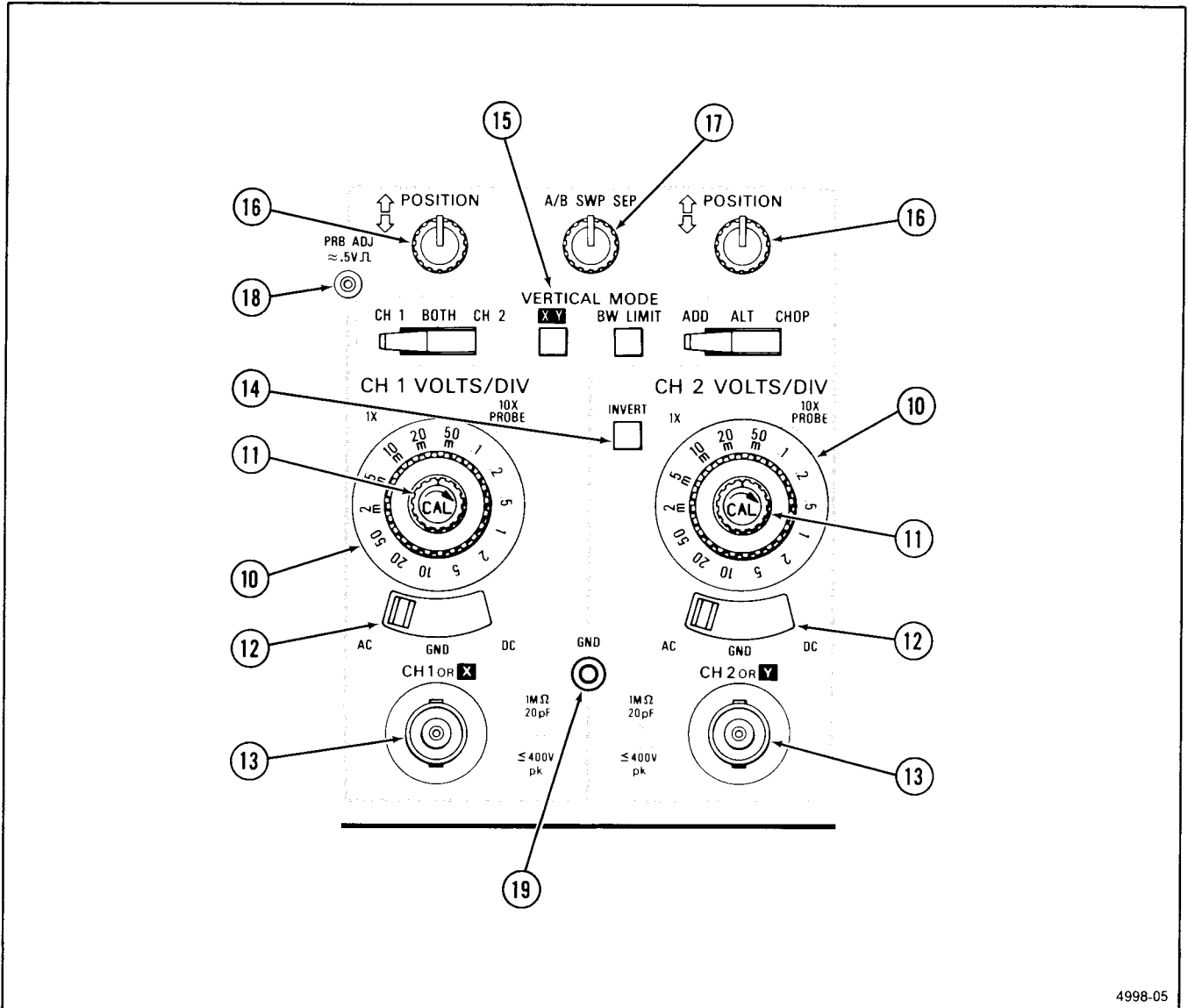

4998-05

Figure 3-2. Vertical controls and connectors.

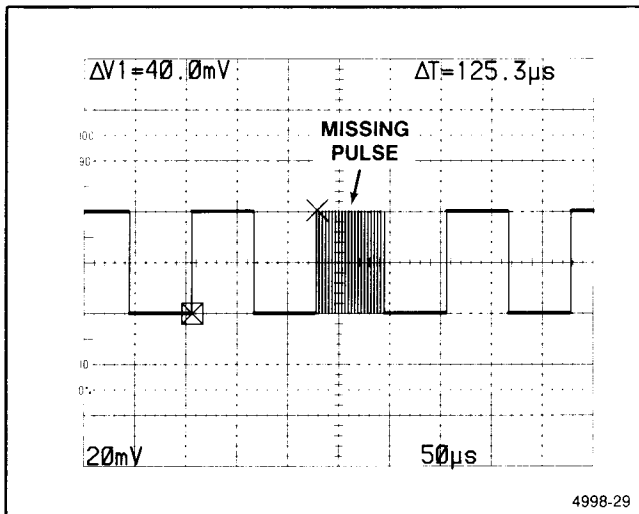

Figure 6-16. Missing pulse, ACCPEAK STORE mode.

1. Preset instrument controls and obtain a baseline trace.

2. Set the STORE/NON STORE switch to the STORE position (button in).

3. Select the triggers, SEC/DIV setting, and storage window (PRETRIG or POST TRIG) to display the pulse train of interest.

4. Select ACCPEAK STORE mode from the Menu.

If the waveform acquired is repetitive, each pulse in it will show only the pulse outline. A pulse missing or present part of the time will show a completely filled display at the pulse location. Pulse breakdown (erratic changes in amplitude or width) will also be displayed by this storage mode.

MAKING NONSTORAGE MEASUREMENTS

The following procedures will enable the operator to perform some basic measurements and familiarize the operator with the conventional oscilloscope capabilities of the instrument.

AC PEAK-TO-PEAK VOLTAGE

To make a peak-to-peak voltage measurement, use the following procedure:

NOTE

This procedure may also be used to make voltage measurements between any two points on the waveform.

1. Preset instrument controls and obtain a baseline trace.

2. Apply the ac signal to either vertical-channel input connector and set the VERTICAL MODE switches to display the channel used.

3. Set the appropriate VOLTS/DIV switch to display about five divisions of the waveform, ensuring that the VOLTS/DIV Variable control is in the CAL detent.

4. Adjust the A TRIGGER LEVEL control to obtain a stable display.

5. Adjust the A SEC/DIV switch to display several cycles of the waveform.

6. Vertically position the displayed waveform so that the negative peak of the waveform coincides with one of the horizontal graticule lines (see Figure 6-17, Point A).

7. Horizontally position the display so that one of the positive peaks coincides with the center vertical graticule line (see Figure 6-17, Point B).

Controls, Connectors, and Indicators—2230 Operators

If properly coded probes (1X, 10X, or 100X, see Table 3-1) are connected to a channel input connector, the crt VOLTS/DIV readout will reflect the correct deflection factor of the display.

Table 3-1
Probe Coding

Probe	Coding Resistance
1X	Infinite
10X	11 k Ω \pm 10%
100X	5.6 k Ω $-$ 10% to 6.2 k Ω $+$ 10%
IDENTIFY	0 Ω or none of the above

- 11 Variable VOLTS/DIV Controls**—Provide continuously variable uncalibrated deflection factors between the calibrated positions of the VOLTS/DIV controls. The VOLTS/DIV sensitivity is reduced by up to at least 2.5 times the sensitivity at the fully counterclockwise position of the variable knob. A detent at the fully clockwise position indicates the calibrated VOLTS/DIV position of the variable knob. The uncalibrated condition is indicated by a greater-than symbol (>) in front of the affected VOLTS/DIV readout.

- 12 AC-GND-DC (Input Coupling) Switches**—Select the method of coupling the input signal to the CH 1 and CH 2 vertical amplifiers and the storage acquisition system.

AC—Capacitively couples the input signal to the vertical deflection and signal acquisition systems. The DC component of the input signal is blocked. The lower -3 dB bandpass is 10 Hz or less. Selection of AC input coupling is indicated in the readout by a tilde symbol (~) over the V on the associated channel's VOLTS/DIV readout.

GND—Grounds the input of the vertical amplifier; provides a zero (ground) reference voltage display (does not ground the input signal). In STORE mode, the ground reference is acquired and displayed in the first sample location of the acquisition waveform display. When GND input coupling is selected, a ground symbol is displayed in the associated VOLTS/DIV readout.

DC—All frequency components of the input signal are coupled to the vertical deflection and signal acquisition systems. When DC input coupling is selected, no additional indicators are displayed with the associated VOLTS/DIV readout.

- 13 CH 1 OR X and CH 2 OR Y Input Connectors**—Provide for application of signals to the inputs of the vertical deflection system and the storage acquisition system.

Coding-ring contacts on each of the input connectors are used to automatically switch the scale factor displayed by the crt readout when a properly coded probe is attached to the input connector. Displayed STORE mode waveforms are reformatted to maintain the correct deflection as indicated by the VOLTS/DIV readout on the affected channel(s). In X-Y mode, the signal connected to the CH 1 OR X input controls the horizontal deflection, and the signal connected to the CH 2 OR Y input controls the vertical deflection.

- 14 CH 2 INVERT Switch**—Inverts the Channel 2 display and STORE mode Channel 2 acquisition signal when pressed in. An invert symbol (I) is displayed with the CH 2 VOLTS/DIV readout when CH 2 is inverted. With CH 2 inverted, the oscilloscope may be operated as a differential amplifier when the Vertical MODE of BOTH-ADD is selected.

- 15 VERTICAL MODE Switches**—Select the mode of operation for the vertical amplifier. There are two three-position switches and one two-position switch that determine display and acquisition modes and one two-position push-button switch that controls the nonstore bandwidth.

CH 1—Selects only the Channel 1 input signal for acquisition or display.

BOTH—Selects a combination of Channel 1 and Channel 2 input signals for acquisition or display. The CH 1-BOTH-CH 2 switch must be in the BOTH position for ADD, ALT, and CHOP operation.

CH 2—Selects only the Channel 2 input signal for acquisition or display.

ADD—Displays (NON STORE) or acquires and then displays (STORE) the sum of the Channel 1 and Channel 2 input signals when BOTH is also selected. The difference of the Channel 1 and Channel 2 input signals is displayed (NON STORE) or acquired and then displayed (STORE) when the Channel 2 signal is inverted.

ALT—Alternately displays the nonstore Channel 1 and Channel 2 input signals. The nonstore alternation occurs during retrace at the end of each sweep. ALT Vertical MODE is most useful for

GLITCH MEASUREMENT. Once a glitch has been observed, you may wish to obtain measurements of amplitude and pulse width. The following procedure may be used to acquire the glitch in STORE mode using delayed sweep. By selecting appropriate trigger sources, the procedure may be used for any similar waveform situation (i.e., selecting triggers that set up a storage window containing the pulse, or glitch, to be acquired).

To view the glitch in the pulse train for measurement purposes:

1. Preset instrument controls and obtain a baseline trace, with the following exceptions:

STORE/NON STORE	STORE (button in)
TRIG MODE	NORM
A TRIGGER SOURCE	EXT (error event)
HORIZONTAL MODE	BOTH

2. Adjust the A TRIGGER SLOPE and LEVEL controls for a stable display of the A trace. Set the B TRIGGER LEVEL control fully cw.

3. Set the A SEC/DIV switch to display the portion of the pulse train containing the glitch. Pull the B SEC/DIV knob to unlock it from the A SEC/DIV switch, and set the B SEC/DIV switch to reduce the intensified zone to the size of the area of interest (see Figure 6-15A).

4. Use the B DELAY TIME POSITION control to move the intensified zone to the area of the signal containing the glitch.

5. Set the HORIZONTAL MODE switch to B.

6. Using the Menu, select either PEAKDET or ACCPEAK Acquisition mode.

7. Adjust the INTENSITY control as necessary for desired display brightness. The glitch should be seen in the display (see Figure 6-15B). It may be expanded further by setting the B SEC/DIV switch to faster sweep speeds (see Figure 6-15C).

8. Set the SAVE/CONTINUE switch to the SAVE position (button in) to hold the acquired waveform and provide a more stable display for measurement. The SAVE ACQUISITION mode display may be horizontally expanded up to 10 times using the SEC/DIV switch (if enough

SEC/DIV switch positions remain) and vertically expanded up to 10 times, using the VOLTS/DIV switch associated with the channel from which the signal was acquired.

NOTE

PEAKDET Acquisition mode will catch at least 50% of the amplitude of a pulse as narrow as 100 ns. If the glitch is repetitive, its shape may be observed at sweep speeds faster than 5 μs per division (REPETITIVE Store sampling).

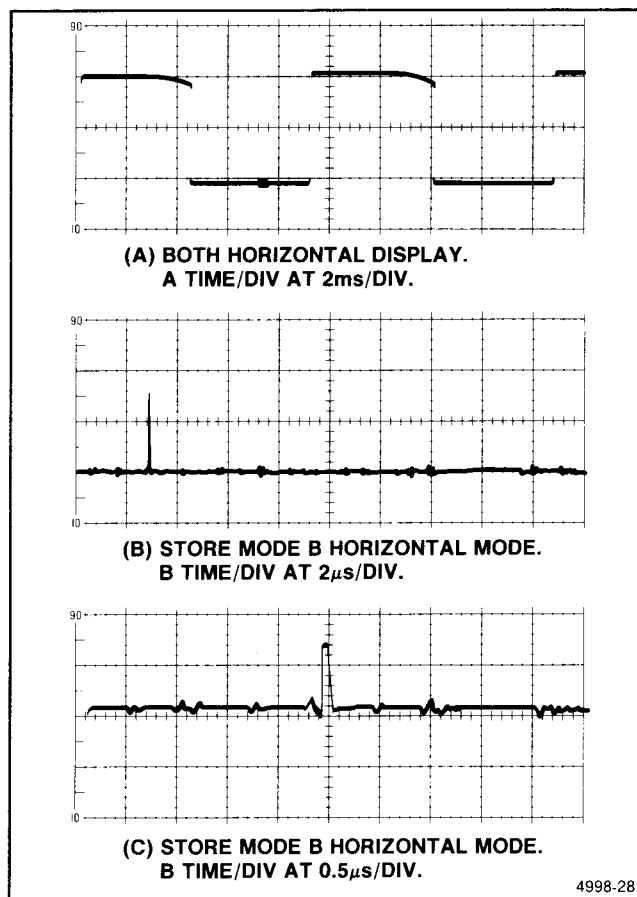

Figure 6-15. Glitch display, STORE mode using B HORIZONTAL MODE.

MISSING PULSE. ACCPEAK mode is useful for finding an intermittent pulse in a pulse train. The pulse may either be missing or present erratically. In either case, the change in amplitude levels is displayed as a completely filled in pulse (see Figure 6-16).

acquiring and viewing both channel input signals at sweep rates of 0.5 ms per division and faster. Channel 1 and Channel 2 STORE mode signals are acquired on alternate acquisition cycles at one-half the sampling rate of a single-channel acquisition.

CHOP—Switches the nonstore display between the Channel 1 and Channel 2 vertical input signals during the sweep. The chopped switching rate for NON STORE mode (CHOP frequency) is approximately 500 kHz. Chopped STORE mode signals are acquired on alternate time-base clock cycles with each channel being acquired at one-half the sampling rate of a single-channel acquisition. In STORE mode at sweep speeds of 5 μ s per division or faster, CHOP becomes ALT mode.

BW LIMIT Switch—When pressed in while in NON STORE mode, the bandwidth of the vertical amplifier system and the A Trigger system is limited to approximately 20 MHz. This reduces interference from unwanted high-frequency signals when viewing low-frequency signals. In STORE mode, pressing in the BW LIMIT switch reduces only the trigger bandwidth. Press the switch a second time to release the switch and regain full bandwidth.

X-Y Switch—Automatically selects X-Y mode when pressed in. The CH 1 input signal provides horizontal deflection for X-Y displays, and the CH 2 input signal provides vertical deflection. In STORE mode, CH 1 and CH 2 signals are acquired in a chopped manner with no more than 100 ns between corresponding sample points on opposite channels, with the CH 1 signal being sampled before the CH 2 signal. The sampling mode and sampling rate are controlled by the A or the B SEC/DIV switch (depending on the Horizontal Display mode). The sampling rate is displayed in the crt readout in either the A or the B SEC/DIV display area (as appropriate), with the readout not in use being blanked. The X-Y waveform is acquired in SAMPLING mode and displayed with dots.

- 16 **Vertical POSITION Controls**—Control the vertical display position of the CH 1 and CH 2 signals.

In STORE mode, the controls determine the vertical position of displayed waveforms during acquisition and in SAVE mode. Any portions of a signal being acquired that are outside the dynamic range of the A/D converter are blanked when positioned on screen. The Vertical POSITION controls can also reposition a vertically expanded SAVE waveform so

that portions of the waveform outside the graticule area can be observed.

In NON STORE X-Y mode, the CH 2 POSITION control vertically positions the display, the horizontal POSITION control positions the display horizontally, and the CH 1 POSITION control is not active. In STORE mode, the CH 1 POSITION control is active, and both it and the Horizontal POSITION control affect the horizontal position of the displayed waveform.

- 17 **A/B SWP SEP Control (NON STORE only)**—While in NON STORE mode, vertically positions the B Sweep trace with respect to the A Sweep trace when the HORIZONTAL MODE is BOTH.
- 18 **PRB ADJ Connector**—Provides an approximately 0.5 V, negative-going, square-wave voltage (at approximately 1 kHz) for compensating voltage probes and checking the operation of the oscilloscope's vertical system. It is not intended to verify the accuracy of the vertical gain or the horizontal time-base circuitry.
- 19 **GND Connector**—Provides an auxiliary ground connection directly to the instrument chassis via a banana-tip jack.

HORIZONTAL

Refer to Figure 3-3 for location of items 20 through 26.

- 20 **SEC/DIV Switches**—Determine the SEC/DIV setting for both the NON STORE sweeps and the STORE mode waveform acquisitions. To obtain calibrated A and B NON STORE sweeps, the Variable SEC/DIV control must be in the CAL detent.

In STORE mode, the SEC/DIV switches determine the default acquisition and display modes, set the sampling rate, and establish the seconds-per-division scale factor of the displayed waveforms. The SEC/DIV parameters displayed on the crt readout are for the waveforms identified by CURSORS.

Table 3-2 lists the default Storage, Acquisition, Process, and Display modes with respect to the SEC/DIV setting and the selected Trigger mode. Waveforms of SCAN, and ROLL displays are updated one data point at a time. All data points of a RECORD display are updated at the same time (total record replacement).

ANTI-ALIASING. In the event that an alias is suspected, three things may be done to determine whether the display is of an alias. The first is to switch back to NON STORE mode to determine if the input signal is higher in frequency than the apparent signal being displayed (see Figure 6-13B). Ensure that this display is being triggered as indicated by the TRIG'D LED being illuminated. The second is to use either the ACCPEAK or the PEAKDET storage modes (PEAKDET is the default mode for SEC/DIV settings from 5 s per division to 20 μ s per division), which hold the maximum, and minimum points being acquired. PEAKDET storage mode holds the maximum and minimum points acquired in a single trigger cycle, and ACCPEAK accumulates the maximum and minimum points acquired over many trigger cycles. Since the maximum and minimum points of the alias waveform do not occur at exactly the same point in relation to the trigger each time, the display soon acquires maximum and minimum amplitude levels in every storage address and the top and bottom of the alias display become flat lines (see Figure 6-13C).

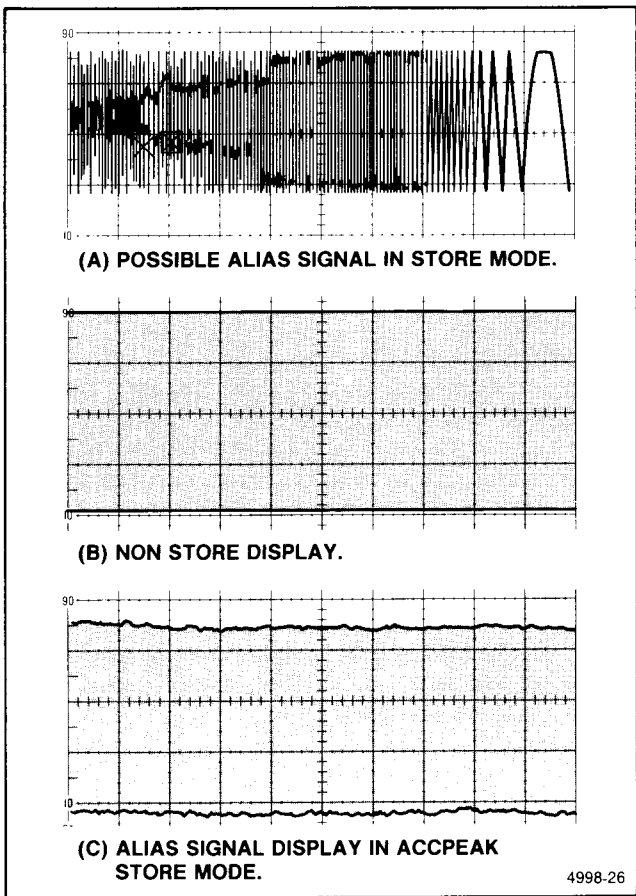

Figure 6-13. Anti-aliasing.

Third, if an alias is detected, the SEC/DIV switch may be set for a faster sweep rate so that the number of samples per cycle of the input signal is increased. However, at sweep speeds of 2 μ s per division and faster, the sampling rate is not increased; and if an alias signal is still present at 5 μ s per division, the frequency limit of the digital circuitry has been exceeded for non-repetitive signals. When the SEC/DIV switch is set for sweep speeds faster than 5 μ s/div, Repetitive Store acquisition mode and AVERAGE are selected. On repetitive signals, the random phase between successive triggers and the time-base clock suppress aliased waveform displays as a result of the increased effective sample rate.

GLITCH CATCHING. Pulses that are present for a very short time duration during the viewing of longer pulse duration signals, such as a logic pulse train, may not be visible at the sweep speed in use (see Figure 6-14A). In digital logic circuitry, a small switching transient (glitch) may cross the logic threshold level and cause an error. Setting up the instrument to trigger on the error event should position the storage window to acquire the pulse train that contains the glitch.

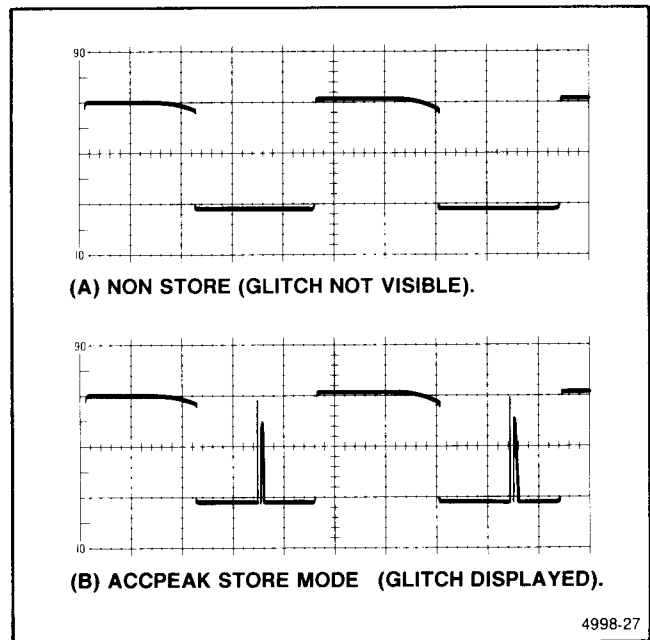

Figure 6-14. Glitch display, ACCPEAK Store mode.

To catch a glitch, first select PRETRIG ACQUISITION mode. This will acquire 7/8 of a waveform occurring before the trigger. Select ACCPEAK mode using the Menu. This will acquire the waveform maximum and minimum points over a selected number of sweeps. The location of the glitch will be displayed in the accumulative envelope display (see Figure 6-14B).

Controls, Connectors, and Indicators—2230 Operators

A SEC/DIV Switch—Selects the calibrated A Sweep rates from 0.5 s to 0.05 $\mu\text{s}/\text{div}$ in a 1-2-5 sequence of 22 steps for the A Sweep generator and sets the delay time scale factor for delayed-sweep operation.

In STORE mode, the A SEC/DIV switch controls the default Storage, Acquisition, Process, and Display modes when making acquisitions using the A Time Base. It also selects the external clock signal, from the EXT CLK input, for the storage acquisition circuitry.

B SEC/DIV Switch—Selects the calibrated B Sweep rates from 50 ms/div to 0.05 $\mu\text{s}/\text{div}$ in a 1-2-5 sequence of 19 steps.

In STORE mode, the B SEC/DIV switch controls the default Storage, Acquisition, Process, and Display modes when making acquisitions using the B Horizontal mode.

UNTRIGGERED mode performs acquisitions without reference to the trigger circuit, and there is no trigger marker on the screen. Triggers are ignored in STORE mode at SEC/DIV settings of 5 s per division to 0.1 s per division under the following conditions:

ROLL is selected. Selecting ROLL forces the screen to continuously update as on a chart recorder. Triggers would stop the display. ROLL is operational at sweep speeds slow

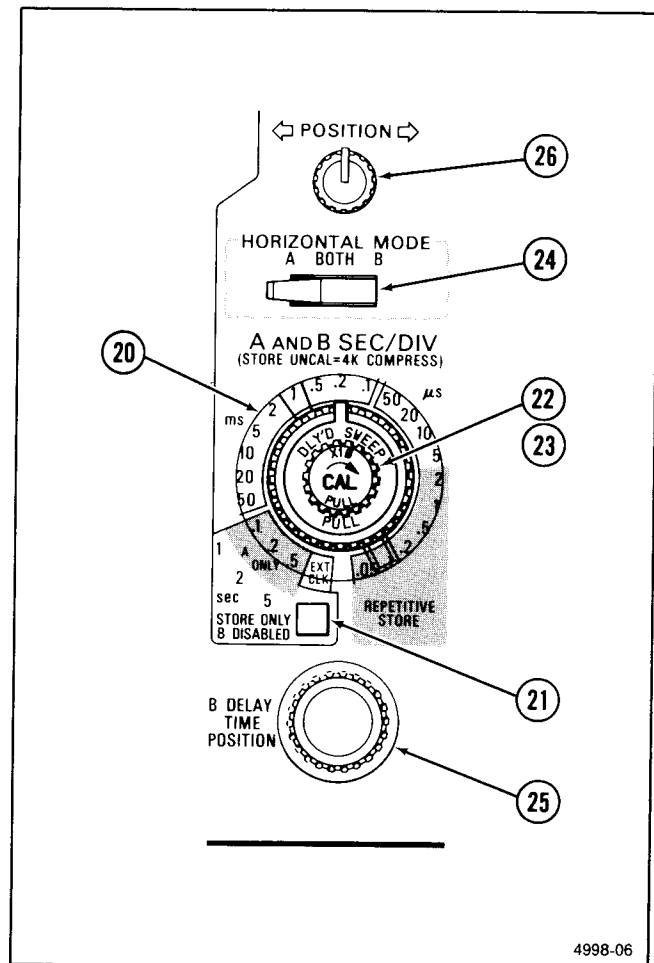

Figure 3-3. Horizontal controls.

Table 3-2
Default Digital Storage Modes

	UN-TRIG ^a 5 s to 0.1 s	TRIG ^b 5 s to 0.1 s	SLOW RECORD 50 ms to 20 μs	FAST RECORD 10 μs to 5 μs	REPETITIVE 2 μs to 0.05 μs
SAMPLE ^c	OFF	OFF	OFF	ON	OFF
AVERAGE ^c	—	OFF	OFF	OFF	ON
ACCPEAK ^c	—	OFF	OFF	OFF	OFF
PEAKDET ^c	ON	ON	ON	—	—
SMOOTH ^d	ON	ON	ON	OFF	OFF
VECTORS	ON	ON	ON	ON	DOTS only

^aSee the “UNTRIGGERED” discussion.

^bSee the “TRIGGERED” discussion.

^cThese Storage modes are mutually exclusive.

^dWorks with ACCPEAK and PEAKDET only.

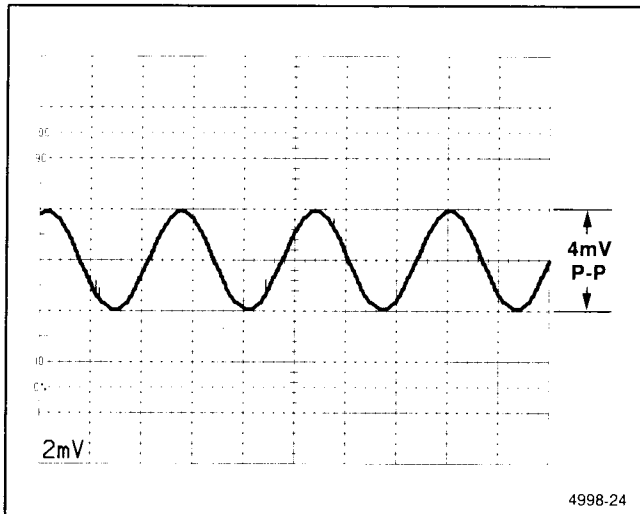

Figure 6-11. Low-level signal, STORE mode.

Figure 6-12 is an illustration of the same signal level as displayed in Figure 6-11, but the waveform was averaged before being displayed. Low-level signals can be acquired in the same manner as explained in previous acquisition procedures. External triggering may be helpful for producing a stable display if the amplitude of the signal being acquired is very low. All measurement procedures described in the preceding part of this manual are also valid for low-level signals.

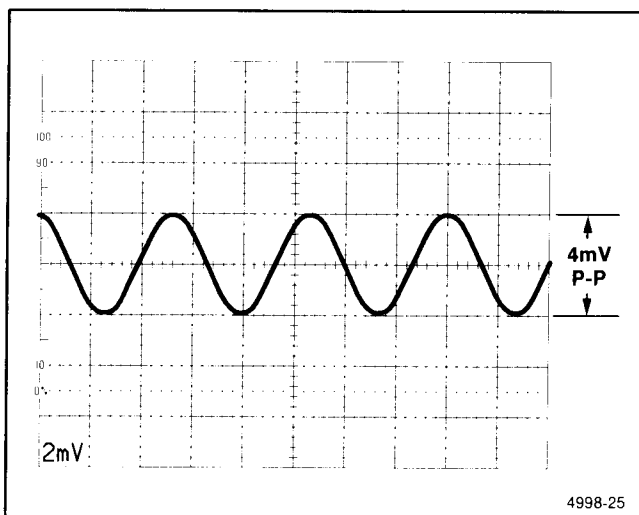

Figure 6-12. Low-level signal, AVERAGE mode.

Observing and Removing Aliases in Store Mode

ALIASING. This discussion assumes the acquisition mode is set to SAMPLE. In digital sampling, the accuracy of the reproduced waveform, when displayed, increases with the number of samples obtained during one full cycle of the signal. That is, a more accurate reproduction of a signal is possible when more samples of the signal are obtained. The instrument displays 1000 samples across the full 10 horizontal divisions of the graticule when in the STORE mode. This means that a sine wave spread across the full screen is sampled 1000 times, but if the sine wave is only one graticule division in width, it will be sampled one-tenth as many times (100 samples). This number is still adequate for accurate reproduction of the stored waveform.

If the SEC/DIV switch is set so that the entire sine-wave period fills one-tenth of a graticule division, it is sampled only 10 times during its acquisition. This means that only ten samples of the waveform will be available to reproduce the waveform for display. In theory, if a sine wave is sampled at least two times during its period, it may be accurately reproduced. In practice, the sine wave can be reconstructed, using special filters, from slightly more than two samples.

At 5 μ s per division, the instrument's SAMPLE mode has a useful storage bandwidth of 2 MHz and a maximum sampling rate of 20 MHz. Consequently, a signal at the upper frequency limit is sampled a minimum of 10 times during the complete sine-wave period (20 times for 2 periods), and the waveform will be accurately reproduced.

If the input frequency is increased beyond 8 MHz, the samples will soon become less than two times per period. This occurs at 10 MHz for a 20 MHz sample rate. Past this point, information sampled from two different sine-wave periods would be used to reconstruct the displayed waveform. Obviously, this waveform could not be a correct reproduction of the input signal. At certain input frequencies the data sampled would reproduce what appears to be a correct display, when in fact it was only related to the input signal by some multiple or part of a multiple of the input signal. This type of display is one type of "alias" (see Figure 6-13A).

The example given is for the maximum sampling rate of 20 MHz. However, the sampling rate is controlled by the SEC/DIV switch, and whenever it is set so that the input signal is sampled less than 10 times per period of the fastest frequency component, observable aliases occur.

enough that the acquisition can manually be stopped when events of interest are observed.

P-P AUTO is selected. P-P AUTO provides a baseline in the absence of triggers from the input signal. The circuit considers the absence of triggers to be about half of a second without a trigger. Below 50 ms per division, the triggers are prevented for longer than that by the sweep time itself, therefore triggers are ignored.

TRIGGERED mode performs triggered acquisitions in STORE mode at SEC/DIV settings of 5 s per division to 0.1 s per division when triggers can be meaningful. Triggers are meaningful in SCAN mode if the A TRIGGER mode is NORM or SGL SWP. Triggers are not meaningful in ROLL mode or in the A TRIGGER Mode of P-P AUTO.

REPETITIVE Store mode (2 μ s/div to 0.05 μ s/div) requires a repetitive trigger signal. Sampling occurs at the maximum A/D conversion rate. If a control affecting an acquisition parameter or function is changed, the acquisition is reset, and the waveform being acquired is cleared on the next sample acquired. On each valid trigger, 10 or more equally spaced samples are acquired and displayed on the waveform record, depending on the SEC/DIV setting (see Table 3-3). The random time delay from the trigger to the following sample clock transition is measured by the Clock Delay Timer circuit and used to place the acquired waveform samples in the correct display memory location. Any display location is equally likely to be filled. Table 3-3 gives the statistically expected number of trigger events required to completely fill the display, assuming a uniform distribution of trigger events relative to the sample interval.

FAST RECORD Storage mode (5 μ s/div to 10 μ s/div) updates a full record of the acquired waveform.

SLOW RECORD Storage mode (20 μ s/div to 50 ms/div) updates a full record of the acquired waveform.

SCAN Storage mode (for NORM TRIGGER mode and 0.1 s/div to 5 s/div or EXT CLOCK) updates pretrigger data when a trigger is received. The waveform display then scans to the right from the trigger point to finish the post-trigger acquisition and then freezes.

SCAN Storage mode (for P-P AUTO TRIGGER mode with auto triggers disabled and 0.1 s/div to 5 s/div or EXT CLOCK) continuously updates the display serially as each data point is acquired. It writes over previous data from left to right.

ROLL Storage mode (P-P AUTO TRIGGER mode and 0.1 s/div to 5 s/div or EXT CLOCK) continuously acquires and displays signals. Triggers are disabled. The waveform display scrolls from right to left across the crt with the latest samples appearing at the right edge of the crt.

SCAN-ROLL-SCAN Storage mode (SGL SWP TRIGGER mode and 0.1 s/div to 5 s/div or EXT CLOCK) serially updates the display. The waveform display SCANS left to right until the pretrigger record is filled, and then ROLLS right to left until a trigger is received. It then SCANS left to right again to fill the post-trigger acquisition record and then freezes (see SGL SWP description for further details).

PEAKDET Acquisition mode digitizes and stores, in acquisition memory as a data pair, the minimum and maximum levels of the input signal within the time represented by 1/50 of a division UN-MAG (1/25 division in CHOP or ALT).

SAMPLE samples the signal at a rate that produces 100 samples per graticule division. In the RECORD Sampling modes, the displayed sample points are displayed by vectors or dots. For REPETITIVE Store mode, the sample points are displayed as dots.

Table 3-3
Repetitive Store Sampling Data Acquisition

SEC/DIV Switch Setting	Samples Per Acquisition		Expected Acquisition Per Waveform ^a	
	1K Mode	4K Mode	1 Channel	2 Channel
0.05 μ s	10	40	519	450
0.1 μ s	20	80	225	191
0.2 μ s	40	160	96	83
0.5 μ s	100	400	30	23
1 μ s	200	800	12	11
2 μ s	200	800	12	11

^aExpected acquisitions per waveform for a 50% probability of fill.

Basic Applications—2230 Operators

Substituting these values into the equation:

$$\text{Phase Shift (degrees)} = \frac{6.3 \times 10^{-3} \text{ s}}{34.8 \times 10^{-3} \text{ s}} \times 360^\circ = 65.17^\circ$$

Slope

The slope of a particular portion of a waveform is the rate of change of voltage with respect to time. The following procedure is useful for making the measurements required for determining the slope of a portion of a waveform.

1. Preset instrument controls and obtain a baseline trace.
2. Set the STORE/NON STORE switch to the STORE position (button in).
3. Set the VOLTS/DIV switch to obtain about 5 divisions of vertical amplitude.
4. Set the A SEC/DIV switch to horizontally spread the portion of the waveform to be measured across the width of the graticule area (see Figure 6-10).

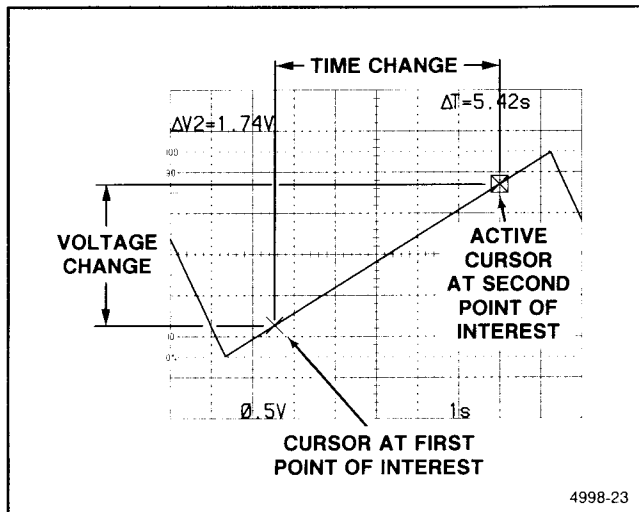

Figure 6-10. Slope using cursor.

5. Set the SAVE/CONTINUE switch to the SAVE position (button in) to save the acquired waveform and to provide a more stable display for measurement.

6. Set the POSITION CURS/SELECT WAVEFORM switch to the POSITION CURS position (button in).

7. Use the CURSORS control to move the active cursor to the first point of interest.

8. Push the SELECT C1/C2 button to select the other cursor, and use the CURSORS control to position the cursor to the second point of interest.

9. Read the voltage difference between cursors from the crt readout.

10. Read the time difference between the two measurement points from the crt readout.

11. Slope is determined by using the measured voltage and time to calculate the rate of change using the following formula:

$$\text{Slope (rate of change)} = \frac{\text{Change in voltage}}{\text{Change in time}}$$

As an example, in Figure 6-10, the voltage difference between the measurement points is 1.74 V, and the time difference is 5.42 s.

Substituting these values into the formula:

$$\text{Slope} = \frac{1.74 \text{ V}}{5.42 \text{ s}} = 0.32 \text{ V/s}$$

Low-Level Signal Measurements

A displayed signal acquired in STORE mode at 5 mV per division may be vertically expanded up to 10 times by using the MENU. Figure 6-11 is an illustration of a 4 mV peak-to-peak signal being displayed at 2 mV per division. The stair-step pattern is due to the small changes of signal applied to the digitizing circuitry when STORE mode is used to acquire the waveform. The numerous spikes in the waveform are due to the noise accompanying the signal.

The AVERAGE Processing mode may be used to reduce, or even eliminate, the noise displayed with the signal. Even though the signal-level changes applied to the digitizing circuitry are small, processing of the average waveform data results in a smooth display of the signal.

AVERAGE Acquisition mode can be used for multiple record averaging. A normalized algorithm is used for continuous display of the signal at full amplitude during the averaging process. The amplitude resolution increases with the number of weighted acquisitions included in the display. The default mode for REPETITIVE Store mode is AVERAGE. The averaging weight (the number of weighted waveform acquisitions included in each average display) is MENU selectable. The default average weight is 1/4. The number of sweeps (SWP LIMIT) allowed to occur before averaging stops is also MENU selectable.

SMOOTH Processing mode reorders acquired data for correct slope and interpolates the data for drawing a smooth waveform. Smoothing looks at the change in data point values between adjacent sample intervals. If the change in value does not exceed certain limits, the values are interpreted as a continuous slope for drawing vectors or dots. If the value change exceeds the interpreted "no-change" limit, the data point value is not modified, and the vectors drawn in the display will show a discontinuity in the waveform. This method of display of the waveform data provides a smoothed display of the waveform, yet retains the glitch-catching capabilities of PEAKDET or ACCPEAK modes.

21 STORE Mode A SEC/DIV Multiplier—Functions only in the STORE mode at SEC/DIV switch settings of 0.1, 0.2, and 0.5 s/div. When pressed in, the A Sweep time base of these three settings is increased by a factor of 10 to 1 s/div, 2 s/div, and 5 s/div. Releasing the button returns the STORE mode time base to X1. The X10 MAG control is still functional on waveforms acquired at the slow STORE mode SEC/DIV settings.

22 Variable SEC/DIV and 4K COMPRESS Control—Controls the NON STORE sweep time per division and compresses STORE mode waveform records.

Variable SEC/DIV—Continuously varies the uncalibrated NON STORE sweep time per division to at least four times the calibrated time per division set by the SEC/DIV switch (increases the slowest NON STORE A Sweep time per division to at least 2 s). The Variable SEC/DIV control does not affect the storage time base for acquiring or displaying signals.

4K COMPRESS—If the Variable SEC/DIV control is rotated out of the CAL detent position during waveform acquisitions or SAVE mode, a 4K

record is compressed by a factor of four (4K COMPRESS) to display the acquired data in one display window. For 4K COMPRESS the SEC/DIV is further multiplied by 4.

23 X10 Magnifier Switch—Magnifies the NON STORE displays or expands the STORE acquisition and SAVE waveform displays by 10 times. STORE mode displays are expanded when the Variable SEC/DIV knob is pulled to the out position (X10 PULL). The SEC/DIV scale factor readouts are adjusted to correspond to the correct SEC/DIV of the displayed waveform (either NON STORE or STORE). Magnification of the NON STORE displays occurs around the center vertical graticule division; STORE mode displays are expanded around the active CURSOR. The display window for STORE mode X10 expanded waveforms may be positioned using the CURSORS Control to view any one-window portion of the acquisition record.

24 HORIZONTAL MODE Switch—Determines the operating mode of the horizontal deflection system in both NON STORE and STORE. For STORE mode, the switch selects the acquisition time base and storage mode (either A SEC/DIV or B SEC/DIV).

A—Only the A Sweep is displayed. NON STORE time base and STORE acquisitions are controlled by the A SEC/DIV switch. The A SEC/DIV switch setting is displayed on the crt readout.

BOTH—Alternates the NON STORE display between the A Intensified and B Delayed Sweeps. The STORE mode display is the A Intensified trace only. The intensified zone on the A trace indicates the approximate delay position and length of the B Delayed Sweep. The A SEC/DIV, B SEC/DIV, and B DELAY TIME POSITION settings are displayed on the crt readout. In BOTH, STORE mode acquisitions are controlled by the A SEC/DIV switch.

B—Displays either the NON STORE or the STORE B Sweep trace. The A SEC/DIV, B SEC/DIV, and B DELAY TIME POSITION settings are displayed on the crt readout, just as in BOTH. The STORE mode waveform acquisitions are controlled by the B SEC/DIV switch.

25 B DELAY TIME POSITION Control—Adjusts the delay between the start time of the A Sweep and the time that the B Sweep either starts (RUNS AFTER DLY) or can be triggered (Triggerable After Dly). (The A Sweep does not have to be displayed.) The delay time is variable from 0.5 to 10 times the A SEC/DIV, plus 300 ns.

7. Check that the A TRIGGER LEVEL control is adjusted for a stable, triggered acquisition.

NOTE

Use the NORM Trigger Mode for low-repetition-rate signals (below approximately 20 Hz). This ensures that the storage window and trigger signal are synchronized when the trace is triggered.

8. Set both VOLTS/DIV switches and adjust the VOLTS/DIV Variable controls to obtain a 5-division vertical display of each input signal.

NOTE

Use the Vertical POSITION controls in conjunction with the VOLTS/DIV Variable controls to vertically center the 5-division display between the 0% and 100% dotted reference graticule lines.

9. Set the PRETRIG/POST TRIG switch and A TRIGGER SLOPE switch as necessary to place the measurement points within the graticule area (see Figure 6-9A).

10. Set the SAVE/CONTINUE switch to the SAVE position (button in).

11. Set the POSITION CURS/SELECT WAVEFORM switch to the POSITION CURS position (button in).

12. Use the CURSORS control to move the active cursor to the sine wave's first zero-crossover point (center horizontal graticule line).

13. Push the SELECT C1/C2 button to select the other cursor, and use the CURSORS control to position the active cursor to the sine wave's third zero-crossover point (360°).

14. Note the time of the sine-wave period (T_1) from the crt readout.

15. Use the CURSORS control to position the active cursor to the first zero-crossover point of the phase-shifted signal (see Figure 6-9B).

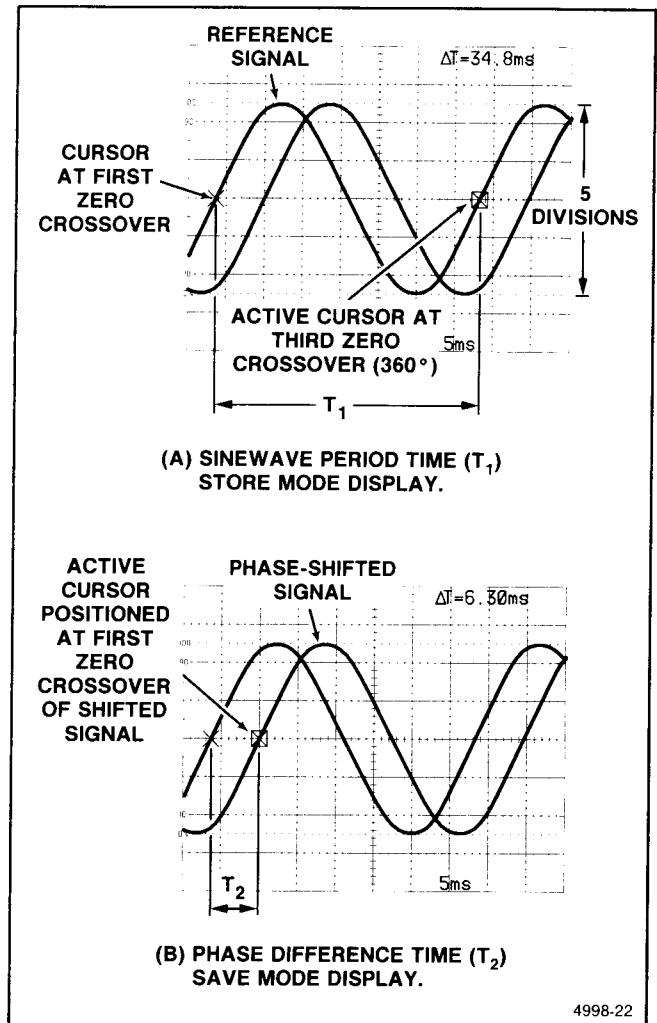

Figure 6-9. Phase difference between sinusoidal signals.

16. Note the phase-difference time (T_2) from the crt readout.

17. The amount of phase shift in degrees is calculated from the following formula:

$$\text{Phase shift (degrees)} = \frac{T_2}{T_1} \times 360^\circ$$

EXAMPLE: The period (T_1) of the reference signal shown in Figure 6-9 is 34.8 ms, and the phase-difference time (T_2) is 6.3 ms.

In Triggerable After Delay, the delay time readout indicates the time that must elapse after the A trigger before the delayed sweep or delayed acquisition can be triggered; not the actual position of the trigger point. However, the readout of the delay time on the crt follows the setting of the B DELAY TIME POSITION control in either B Trigger mode.

The setting of the 1K/4K switch affects the delay time position setting for STORE mode displays by a factor of approximately four times. When switching between 1K and 4K record lengths, the delay time position setting must be readjusted to obtain the same delay time.

- 26 **Horizontal POSITION Control**—Positions all the NON STORE waveforms horizontally over a one-sweep-length range (either X1 or X10 Magnified). Using the Horizontal POSITION control, STORE mode waveforms may be positioned over a range of only one display window. When a STORE mode acquisition display is longer than one screen (as in 4K records and/or X10 MAG), the CURSORS POSITION control is used to position the display window to any position of the acquisition record. The Horizontal POSITION control does not position the crt readout displays.

TRIGGER

Refer to Figure 3-4 for location of items 27 through 38.

NOTE

The Trigger controls affect the acquisition of the next waveform. They are inactive in SAVE Acquisition mode.

- 27 **A TRIGGER Mode Switches**—Determine the NON STORE A Sweep triggering mode. STORE mode triggering depends on the position of the A SEC/DIV, the SCAN/ROLL switch, and the A Trigger mode. The trigger position is marked by a T on acquired waveforms.

NORM—Permits triggering at all sweep rates (an autotrigger is not generated in the absence of an adequate trigger signal). NORM Trigger mode is especially useful for low-frequency and low-repetition-rate signals.

In STORE mode, the last acquired waveform is held on display between triggering events. The pretrigger portion of the acquisition memory is

continually acquiring new pretrigger data until a trigger event occurs. How the waveform display is updated after the trigger occurs, depends on the SEC/DIV setting. From 5 s per division to 0.1 s per division, the pretrigger portion of the displayed waveform is updated by the pretrigger data in the acquisition memory, then the post-trigger data points are placed in the display as they are acquired. For faster sweep speeds, the post-trigger data points are acquired in the acquisition memory prior to completely updating the waveform display, using the newly acquired data.

P-P AUTO—TV LINE—In NON STORE mode, triggering occurs on trigger signals having adequate amplitude and a repetition rate of about 20 Hz or faster. In the absence of a proper trigger signal, an autotrigger is generated, and the sweep free runs.

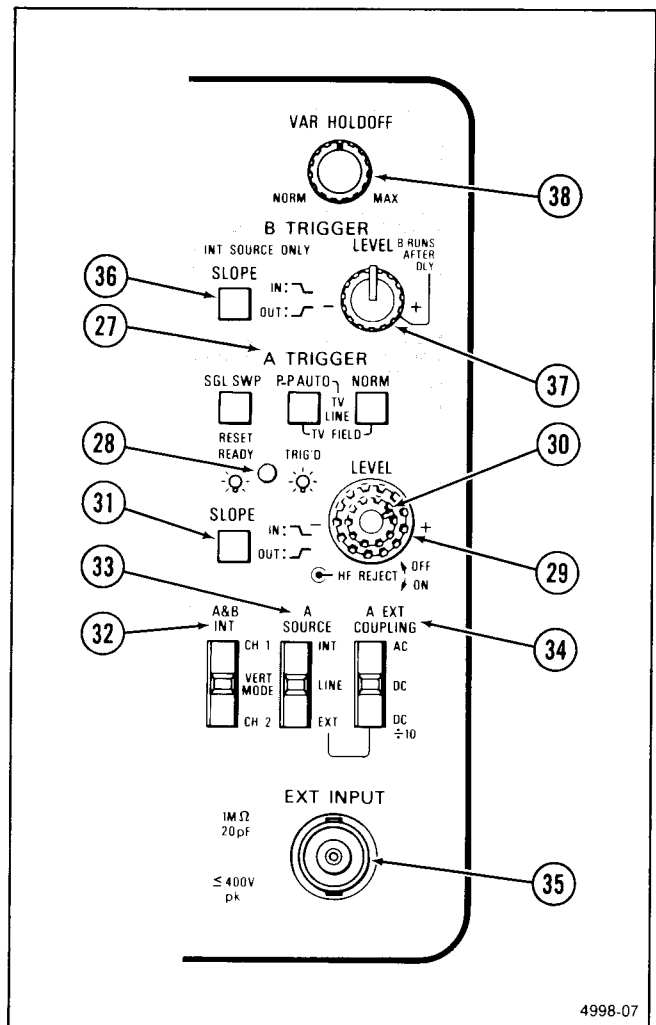

Figure 3-4. Trigger controls, connector, and indicator.

Time Difference Between Two Time-Related Pulses

1. Set the VERTICAL MODE switches to BOTH and ALT.

2. Use probes or coaxial cables with equal time delay to apply the pulse signals to be measured to the input connectors; one to Channel 1 and the second to Channel 2.

3. Set the VOLTS/DIV switches to obtain about three divisions of display amplitude for each signal.

4. Set the STORE/NON STORE switch to STORE (button in), set the A TRIGGER Mode switch to NORM, set the A SOURCE switch to INT, and set the A&B INT switch to CH 1.

5. Adjust the A TRIGGER LEVEL and SLOPE control for a continuous, triggered acquisition of the signals.

6. Set the A SEC/DIV switch to obtain a display of the measurement points on the two pulses between which the measurement is to be made.

7. Set the PRETRIG/POST TRIG switch as required to obtain the entire pulse display.

8. Press the SAVE/CONTINUE switch to the SAVE position (button in) to save the waveform and to present a more stable display for measurement. Cursors will appear on both the Channel 1 and Channel 2 traces in SAVE mode.

9. Set the POSITION CURS/SELECT WAVEFORM switch to the POSITION CURS position (button in).

10. Use the CURSORS control to move the active cursor to the 50% point of the Channel 1 pulse leading edge.

NOTE

Pulses with a fast rise time have only a few sample points on the leading edge, and it may not be possible to place the dot at exactly the 50% level on the leading edge.

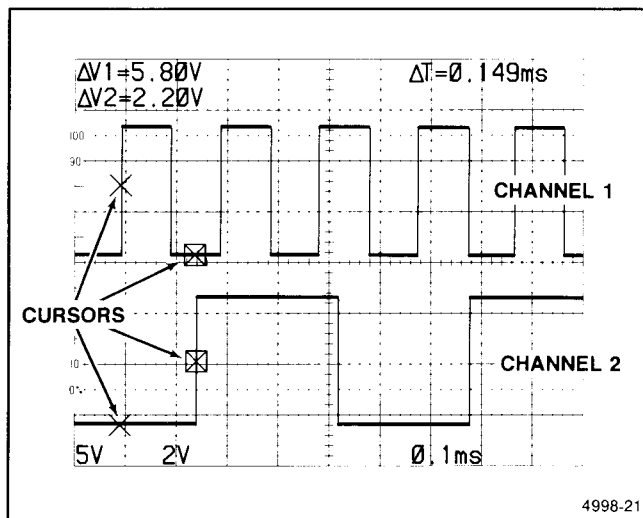

Figure 6-8. Time difference between two time-related pulses.

11. Push the SELECT C1/C2 button to select the other cursor, and use the CURSORS control to position the active cursor at the 50% level of leading edge of the Channel 2 pulse (see Figure 6-8).

12. Read the time difference between the pulses from the crt readout.

Phase Difference Between Sinusoidal Signals

1. Preset instrument controls and obtain a baseline trace.

2. Using probes or coaxial cables with equal time delay, connect the reference signal to the CH 1 OR X input connector and the other (phase-shifted) signal to the CH 2 OR Y input connector.

3. Select a VERTICAL MODE of BOTH and ALT or CHOP, depending on the input signal frequencies.

4. Set the A&B INT switch to the CH 1 position and adjust the A TRIGGER LEVEL control and the A TRIGGER SLOPE control for a stable, triggered display.

5. Use a SEC/DIV switch setting that displays about two cycles of each input signal.

6. Set the STORE/NON STORE switch to the STORE position (button in).

In STORE mode, for SEC/DIV settings of 5 s per division to 0.1 s per division, the P-P AUTO trigger mode is disabled, and the acquisition free-runs. At faster SEC/DIV settings, triggered acquisitions occur under the same conditions as NON STORE mode P-P AUTO triggering, and the acquisition free-runs if proper triggering conditions are not met. The manner in which the display is filled and updated is the same as for NORM triggering.

For either NON STORE or STORE mode, the range of the A TRIGGER LEVEL control is automatically restricted to the peak-to-peak limits of the trigger signal for ease in obtaining triggered displays and acquisitions. P-P AUTO is the usual Trigger mode selection to obtain stable displays of TV Line information.

TV FIELD—Permits stable triggering on a television field (vertical sync) signal when the P-P AUTO and the NORM Trigger buttons are pressed in together. In the absence of an adequate trigger signal, the sweep (or acquisition) free-runs. The instrument otherwise behaves as in P-P AUTO.

SGL SWP—Arms the A Trigger circuit for a single sweep in NON STORE or a single acquisition in STORE. Triggering requirements are the same as in NORM Trigger mode. After the completion of a triggered NON STORE sweep or a STORE SGL SWP acquisition, pressing in the SGL SWP button rearms the trigger circuitry to accept the next triggering event or start the next storage acquisition.

In STORE mode when the SGL SWP is armed, the acquisition cycle begins, but the READY LED does not come on until the pretrigger portion of the acquisition memory is filled. At the time the READY LED comes on, the acquisition system is ready to accept a trigger. When a trigger event occurs, the post-trigger waveform data is stored to complete the single-sweep acquisition. After triggering, the READY LED goes out, and the single sweep cannot be rearmed until the acquisition is completed.

The SEC/DIV switch setting and the STORE mode determine how the display is updated. For settings of 5 s per division to 0.1 s per division, a storage process known as SCAN-ROLL-SCAN is used. The last acquired waveform is erased when SGL SWP is armed, then the pretrigger acquisition scans from the left edge to the trigger position. At that point, the pretrigger portion of the display is rolled left from the trigger position until

a triggering event occurs. Upon receiving an adequate trigger, the post-trigger portion of the display scans from the trigger point to the right until the remaining data points are filled, and then the display freezes.

For SEC/DIV settings of 0.05 s per division and faster, the display is updated as a full record. The previously displayed waveform remains on the crt until the post-trigger portion of the acquisition memory is filled after a triggering event. Then the waveform display is updated with the newly acquired data in its entirety.

28 **READY—TRIG'D Indicator**—A dual-function LED indicator. In P-P AUTO and NORM Trigger modes, the LED is turned on when triggering occurs. In SGL SWP Trigger mode, the LED turns on when the A Trigger circuit is armed, awaiting a triggering event, and turns off again as soon as the single sweep (or acquisition) is triggered.

In STORE mode, pressing the SGL SWP button to arm the trigger circuitry does not immediately turn on the READY LED. The pretrigger portion of the acquisition memory starts filling after the SGL SWP button is pressed in; the READY LED is turned on when the filling is completed. The storage acquisition system is then ready to accept a triggering event. When a triggering event occurs, the READY LED is turned off.

29 **A TRIGGER LEVEL Control**—Selects the amplitude point on the A Trigger signal that produces triggering. The trigger point for STORE mode is identified by a T on the acquired waveform.

30 **HF REJECT Switch**—Rejects (attenuates) the high-frequency components (above 40 kHz) of the trigger signal when the control is in the ON position.

31 **A TRIGGER SLOPE Switch**—Selects either the positive or negative slope of the trigger signal to start the NON STORE A Sweep or to reference the next STORE mode acquisition cycle.

32 **A&B INT Switch**—Determines the source of the internal trigger signal for both the A and the B Trigger Generator circuits.

CH 1—Trigger signal is obtained from the CH 1 input.

VERT MODE—Trigger signal is obtained alternately from the CH 1 and CH 2 input signals if the

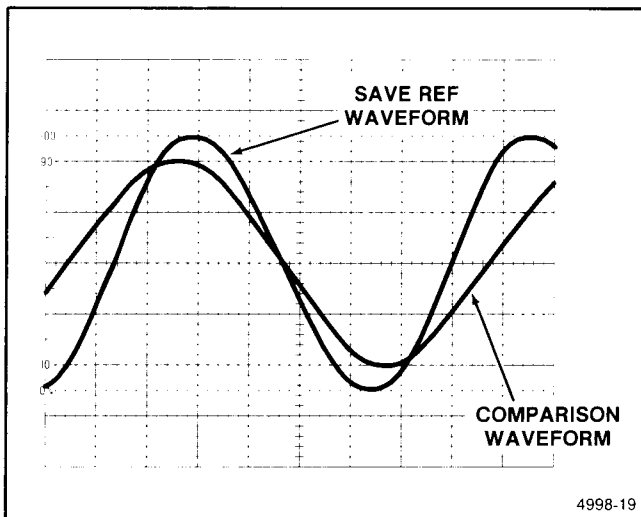

Figure 6-6. Waveform comparison.

9. The acquisition waveform display may be positioned horizontally for comparison with the reference signal by using the following procedure:

- a. Use the B TRIGGER LEVEL control to set the B TRIGGER Source to Starts After Delay.
- b. Set the HORIZONTAL MODE switch to B.
- c. Leave the A and the B SEC/DIV knobs locked together and use the B DELAY TIME POSITION control to move the acquisition waveform display horizontally.

Time Difference Between Repetitive Pulses

1. Preset instrument controls and obtain a baseline trace.

2. Set the STORE/NON STORE switch to the STORE position (button in).

3. Select a VOLTS/DIV switch setting that gives about 5 divisions of display amplitude.

4. Use the selected channel Vertical POSITION control to center the display.

5. Set the A SEC/DIV switch to display the points of interest between which the measurement is to be made.

6. Set the SAVE/CONTINUE switch to the SAVE position (button in) to hold the acquired waveform and to provide a more stable display for measurement.

7. Set the POSITION CURS/SELECT WAVEFORM switch to the POSITION CURS position (button in).

8. Use the CURSORS control to move the active cursor to the 50% level on the leading edge of the first pulse.

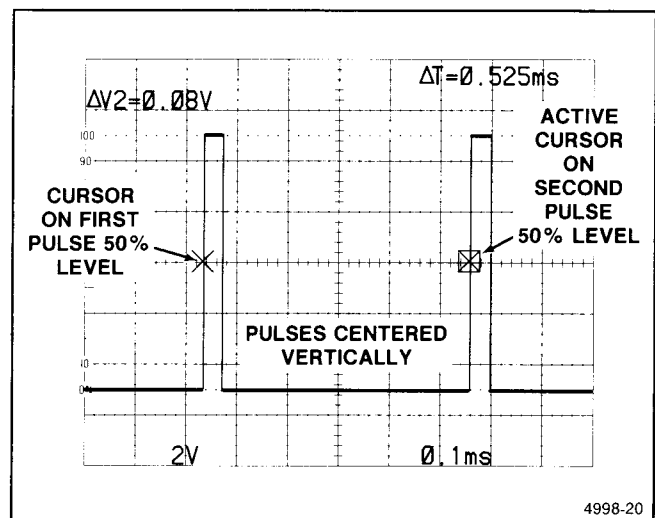

Figure 6-7. Time difference between repetitive pulses.

9. Push the SELECT C1/C2 button to select the other cursor and use the CURSORS control to move the active cursor to the 50% level on the leading edge of the second pulse (see Figure 6-7).

NOTE

Pulses with fast rise times have only a few sample points on the leading edge, and it may not be possible to place the cursor dot at exactly the 50% level.

10. Read the time difference between pulses from the crt readout.

VERTICAL MODE is ALT. In the CHOP VERTICAL MODE, the trigger signal is the sum of the CH 1 and CH 2 input signals.

CH 2—Trigger signal is obtained from the CH 2 input. The CH 2 INVERT switch also inverts the polarity of the internal CH 2 trigger signal so the displayed slope agrees with the Trigger SLOPE switch.

- 33 **A SOURCE Switch**—Determines if the SOURCE of the A Trigger signal is internal, external, or from line.

INT—Routes the internal trigger signal selected by the A&B INT switch to the A Trigger circuit.

LINE—Routes a sample of the ac power source to the A Trigger circuit.

EXT—Routes the signal applied to the EXT INPUT connector to the A Trigger circuit.

- 34 **A EXT COUPLING Switch**—Determines the method of coupling the signal applied to the EXT INPUT connector to the input of the A Trigger circuit.

AC—Input signal is capacitively coupled, and the dc component is blocked.

DC—All frequency components of the external signal are coupled to the A Trigger circuit.

DC ÷ 10—Attenuates the external signal by a factor of 10 before application to the A Trigger circuit. As with DC COUPLING, all frequency components of the input signal are passed.

- 35 **EXT INPUT Connector**—Provides for connection of external signals to the A Trigger circuit.

- 36 **B TRIGGER (INT SOURCE ONLY) SLOPE Switch**—Selects either the positive or the negative slope of the B Trigger signal that starts the NON STORE sweep or completes the STORE acquisition.

- 37 **B TRIGGER LEVEL Control**—Selects the amplitude point on the B Trigger signal where triggering occurs in Triggerable After Delay mode. The B Trigger point is displayed as a T on the STORE mode waveform display when in B Horizontal mode. The fully clockwise position of the B TRIGGER LEVEL Control selects the Runs After Delay mode of operation for the B Trigger circuitry. Out of the cw position, B Sweep is triggerable after the delay time.

- 38 **VAR HOLDOFF Control**—Adjusts the NON STORE Variable Holdoff time over a 10 to 1 range. NON STORE Variable Holdoff starts at the end of the A Sweep. STORE mode Holdoff starts at the end of the acquisition cycle, and ends after the waveform data has been transferred from the acquisition to the display memory and the pretrigger portion of the acquisition memory has been filled. After STORE mode Holdoff ends, the next acquisition can be triggered after the next (or current, if one is in progress) NON STORE Variable Holdoff ends. STORE mode Holdoff may be many times the length of the A Sweep time so that several NON STORE Holdoffs may occur during STORE Holdoff time. This ensures that STORE mode triggering is controllable by the VAR HOLDOFF control and will be stable if the NON STORE display is stable.

STORAGE CONTROLS

Refer to Figure 3-5 for location of items 39 through 42.

- 39 **STORE/NON STORE Switch**—Selects either the NON STORE or the STORE waveforms for display. The STORE acquisition system is turned off while NON STORE is selected, keeping the last-acquired

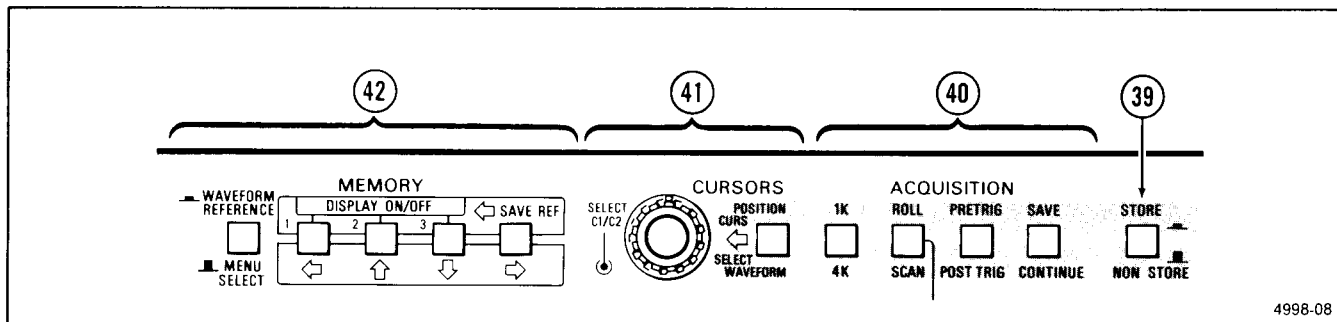

Figure 3-5. Storage controls.

4998-08

Basic Applications—2230 Operators

6. Use the CURSORS control to move the active cursor to the minimum level of the waveform.
7. Push the SELECT C1/C2 button to select the other cursor, and use the CURSORS control to move the active cursor to the maximum level of the waveform.
8. Set the VOLTS/DIV switch and the VOLTS/DIV Variable control (or signal amplitude) for a RATIO readout of 100%.

NOTE

The SAVE ACQUISITION mode button may be pressed in at this time to save the acquired waveform for as long as desired. Voltage and time measurements may be made on the SAVE waveform with less trigger jitter.

9. Use the CURSORS control to move the active cursor down the waveform's leading edge until the RATIO readout is 90%.
10. Push the SELECT C1/C2 button to select the other cursor, and use the CURSORS control to move the active cursor up the waveform's leading edge until the RATIO readout is 80% (see Figure 6-5).

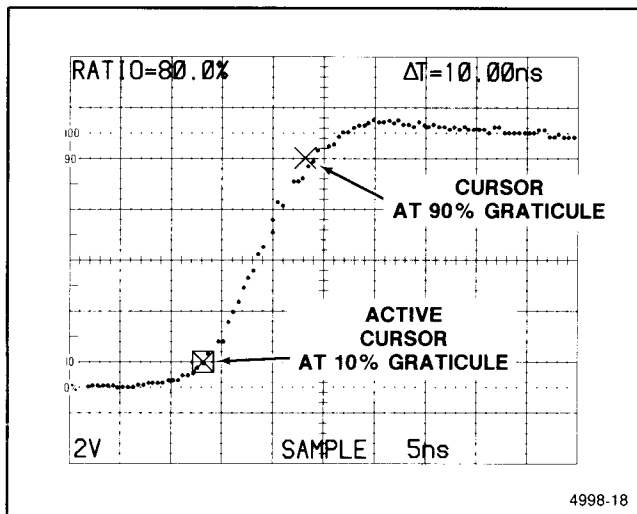

Figure 6-5. Rise time, cursor method.

11. Read the pulse rise time from the crt delta time readout.

Waveform Comparison

Repeated comparisons of newly acquired signals with a reference signal for amplitude, timing, or pulse-shaped analysis may be easily and accurately made using the SAVE REF function of the instrument.

1. Preset instrument controls and obtain a baseline trace.
2. Set the STORE/NON STORE switch to the STORE position (button in).
3. Select a VOLTS/DIV switch setting that gives the desired vertical deflection.
4. Set the A SEC/DIV switch to display the reference signal with the desired sweep rate.
5. Push in the SAVE REF button.
6. Push in the MEMORY 1 button to store the reference waveform into reference memory 1.
7. Acquire the waveform that is to be compared with the reference waveform.

NOTE

A stored reference will remain displayed until the DISPLAY ON/OFF button for the stored reference is again pushed while in WAVEFORM REFERENCE mode. Switching the instrument to NON STORE removes stored waveforms from the display, but the saved reference waveforms remain in the digital storage memory for use upon return to a storage mode. A new reference waveform is saved when the SAVE REF button and then a DISPLAY ON/OFF button are pushed while in WAVEFORM REFERENCE mode.

8. Use the selected channel's Vertical POSITION control to overlay the newly acquired waveform on the reference waveform for making the comparison (see Figure 6-6). The vertical deflection and sweep rate remain calibrated to allow direct measurement from the graticule, or cursors may be used to determine voltage or time differences.

Controls, Connectors, and Indicators—2230 Operators

STORE waveform in memory. Selects NON STORE when out and STORE when pressed in.

- 40 ACQUISITION Controls**—Determine the method of acquiring and displaying the acquired STORE waveform.

1K/4K Switch (Record Length)—Selects an acquisition record length of either one screen (1K) or four screens (4K). Pressing the button in selects 1K record length, and pressing it again to release it returns to 4K record length acquisitions. In either case, the displayed waveform has 100 data points per horizontal graticule division (50 if two channels are acquired).

When a waveform is acquired using the B time base, switching between record lengths also changes the delay time position setting by the same factor of four. The B DELAY TIME POSITION control must be repositioned to obtain the same delay.

When the 4K record length is selected, a one-screen (1K) window of the acquisition is displayed, and a bar graph is used to indicate the position of the displayed window within the record. Turn the CURSORS Position control to move the display window to any position within the record.

The 4K acquisition record can be compressed to a length of 1K by rotating the Variable SEC/DIV control out of the CAL detent position. The SEC/DIV readout is adjusted to reflect the correct time per division of the displayed waveform. The acquisition record may be magnified using the X10 Magnifier.

PRETRIG/POST TRIG Switch—Positions the trigger point for acquisitions either near the end (PRETRIG) or the beginning (POST TRIG) of the waveform. A T is displayed on the waveform to indicate the trigger point. Pressing the button in sets the trigger point to PRETRIG; out is the POST TRIG position.

ROLL/SCAN Switch—Selects either ROLL or SCAN acquisition and display mode. When pressed in (ROLL mode), at SEC/DIV switch settings from 0.1 s per division to 5 s per division the triggers are disabled for NORM and P-P AUTO Trigger modes, and the signals are continuously acquired and displayed. The waveform display scrolls from right to left across the crt with the latest samples appearing at the right edge of the

crt. At SEC/DIV switch settings from 0.1 s per division to 5 s per division in SGL SWP Trigger mode, SCAN/ROLL/SCAN storage mode is selected.

At SEC/DIV switch settings of 0.05 s per division and faster, the ROLL/SCAN switch is not functional, and waveform samples require a triggering event to complete the acquisition before the display is updated.

When the ROLL/SCAN switch is in the out position (SCAN mode), the A TRIGGER Mode controls are functional. For NORM Trigger mode, the pretrigger waveform is updated by the trigger and the post trigger scans from the trigger position to the right. For SGL SWP, SCAN mode is overridden by SCAN/ROLL/SCAN. Triggers are disabled in P-P AUTO and TV FIELD Trigger modes.

SAVE/CONTINUE Switch—Stops the current acquisition and display update in progress when pressed in. Pressing the SAVE/CONTINUE switch a second time releases it and restarts (CONTINUE) the acquisition process. If the SEC/DIV switch setting is 0.1 s per division or slower, the SAVE state is entered immediately upon pressing the button. At SEC/DIV settings of 50 ms per division and faster, if an acquisition has been triggered, the acquisition is allowed to complete before the SAVE state is entered.

The pretrigger portion of an untriggered acquisition stops filling in SAVE mode. When leaving SAVE, a new acquisition is started, and a trigger is not accepted until the pretrigger portion again refills.

- 41 CURSORS Controls**—These controls apply to all displayed STORE mode waveforms. Delta Volts, Delta Time, One Over Delta Time, and Delay Time measurements of the STORE displays are made using the CURSORS controls. Positioning of the display window within a 4K acquisition record length is done using the CURSORS Position control. See the "Crt Readout" description for the cursor readout display.

POSITION CURS/SELECT WAVEFORM Switch—Determines the function of the CURSORS Position control. When pressed in (POSITION CURSORS mode), the CURSORS Position control functions as a cursor horizontal positioning control. When the push button is in the out position (SELECT WAVEFORM mode), the CURSORS Position control is used to position the cursor(s) to the desired waveform(s).

5. If necessary, use the MENU to set the time measurement mode to DELTA TIME (at power-up, the default is DELTA TIME).

6. Set the POSITION CURS/SELECT WAVEFORM switch to the POSITION CURS position (button in).

7. Use the CURSORS control to move the active cursor to the start of the time to be measured.

8. Push the SELECT C1/C2 button to select the other cursor, and use the CURSORS control to move the cursor to the end of the time to be measured.

9. Read the time duration (between the cursors) from the crt readout.

Frequency

1. Preset instrument controls and obtain a baseline trace.

2. Set the STORE/NON STORE switch to the STORE position (button in).

3. Select a VOLTS/DIV switch setting that gives the desired vertical deflection.

4. Set the A SEC/DIV switch to display one complete period of the waveform to be measured.

5. Use the MENU to set the time measurement mode to 1/DELTA TIME.

6. Set the POSITION CURS/SELECT WAVEFORM switch to the POSITION CURS position (button in).

7. Use the CURSORS control to move the active cursor to the start of the frequency to be measured.

8. Push the SELECT C1/C2 button to select the other cursor, and use the CURSORS control to move the cursor to the end of the frequency to be measured.

9. Read the frequency (between the cursors) from the crt readout.

Rise Time

Rise-time measurements use the same methods as time duration, except that the measurements are made between the 10% and 90% points on the leading edge of the waveform. Fall time is measured between the 90% and 10% points on the waveform trailing edge.

1. Preset instrument controls and obtain a baseline trace.

2. Set the STORE/NON STORE switch to the STORE position (button in).

3. Select the appropriate display window and Trigger SLOPE settings that will display the leading edge of the waveform at the start of the trace.

4. Set the SEC/DIV switch for a single-event display, with the rise time spread horizontally as much as possible within the viewing area. The waveform's maximum and minimum levels must still be visible (see Figure 6-4).

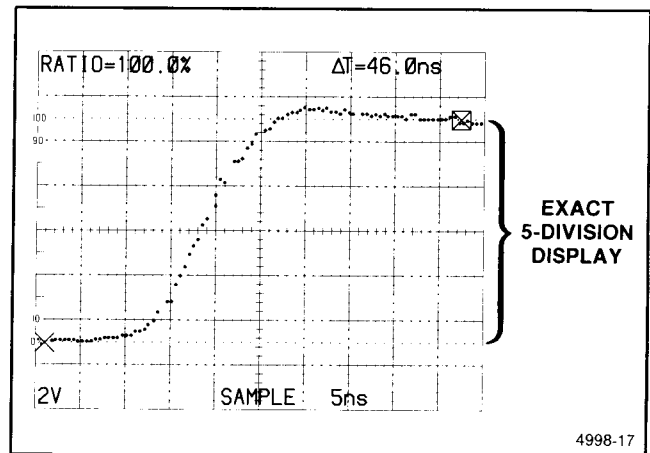

Figure 6-4. Rise-time setup, five-division display.

5. Set the POSITION CURS/SELECT WAVEFORM switch to the POSITION CURS position (button in).

NOTE

Pulses with fast rise times have only a few sample points on the leading edge, and it may not be possible to place the cursor at exactly the 10%, 80%, 90%, or 100% points.

CURSORS Position Control—Provides for either horizontal positioning of the active cursor (or active cursors when there are two waveforms displayed in a display set) or for switching the cursors between waveform display sets. When cursors are positioned to a new waveform set, they return to the position that they had when they were last on that waveform set. Cursor positioning continues to function during SAVE mode, and measurements can be made on any displayed waveform. When SAVE is released, the cursors return to the acquisition waveform set.

Cursors are placed on all waveforms in a display set. A display set is one or both waveforms from the following: Acquisition, CH 1 and CH 2; Reference 1, CH 1 and CH 2; Reference 2, CH 1 and CH 2; and Reference 3, CH 1 and CH 2. Cursors can be placed on SAVE REF waveforms only if in SAVE mode. Cursors move to the acquisition waveform if they were on a SAVE REF waveform that is turned off. The acquisition parameters of the waveform set in which the cursors are located are displayed in the crt readout. Cursors movable by the CURSORS Position control are enclosed in a box.

When the acquisition record length is 4K, a one-screen (1K) window of the record is displayed. A bar graph indicates the position of the display window within the acquisition record. The position of the display window is adjusted to provide a display of the cursor position. If the displayed cursor is positioned to either edge of the display window, further positioning starts the waveform display scrolling in the opposite direction as the display-window position moves. Display-window positioning can be continued to the ends of the record, allowing observations and measurements to be made over the entire 4K acquisition record.

When switching between BOTH (A INTEN in STORE mode) and B ONLY STORE displays, the active cursor is displayed. Cursors in the intensified zone on A INTEN traces switch to their correct relative positions in a B ONLY trace. An active cursor outside the A intensified zone switches to the nearest displayed end of the B ONLY trace. Upon switching back to A INTEN the cursor returns to the correct position in the intensified zone.

SELECT C1/C2 (Cursor-Select) Switch—Selects the cursor(s) that can be positioned by the CURSORS Position control. Cursors are activated alternately with each press of the C1/C2 button. Each selected cursor is enclosed in a box.

42 MEMORY and Menu Controls—These switches control MENU operation while the MENU is displayed, and they control the storage and display of the SAVE Reference waveforms when the MENU is not displayed.

WAVEFORM REFERENCE/MENU SELECT Switch—Selects either the MENU or SAVE REF MEMORY displays. In Waveform Reference mode, the MEMORY switches control the Save Reference Memory. In MENU mode, the MEMORY switches control the Menu, allowing selection of alternate parameters and modes that override the default front-panel settings.

SAVE REF MEMORY CONTROL—When the WAVEFORM REFERENCE/MENU SELECT switch is in the WAVEFORM REFERENCE position (button in), the MEMORY switches control the Save Reference Memory.

SAVE REF/- Switch—Pressing this button just prior to pressing one of the DISPLAY ON/OFF buttons writes the displayed acquisition waveform into the selected Save Reference memory. The written waveform remains displayed on the crt. A control change or a delay of five seconds between pressing the SAVE REF button and selecting a memory location cancels the SAVE request.

Menu Select/DISPLAY ON/OFF Switches—These buttons select one of three memories that is either written to for saving a 1K acquisition waveform (if SAVE REF has been pressed) or toggles the reference memory display on or off (if the SAVE button has not been pressed). The stored waveforms of all three memories can be displayed at the same time. If a SAVE REF memory is chosen for display and no data is stored in that memory, a message to that effect is displayed. Two channels acquired in CHOP or ALT may be stored in a SAVE REF memory.

MENU CONTROL—When the WAVEFORM REFERENCE/MENU SELECT switch is in the MENU SELECT position (button out), the MEMORY switches control Menu Operation. Waveforms are only displayed with menus when a menu choice requires a waveform be displayed in order to perform the selected change. The Menu allows selection of alternate parameters and modes that override the default front-panel settings.

Basic Applications—2230 Operators

3. Set the AC-GND-DC switch to GND and the STORE/NON STORE switch to STORE mode (button in). If the channel signal is being used as the internal trigger source, ensure that the TRIGGER Mode switch is set to P-P AUTO.

4. Use the appropriate channel Vertical POSITION control to move the baseline trace to a convenient reference line. For example, if the voltage to be measured is positive, position the baseline trace to the bottom graticule line; if the voltage is negative, position the baseline trace to the top graticule line; and if the voltage is an alternating signal, position the baseline trace to the center graticule line.

NOTE

If the ground reference is set more than ± 5 divisions from the center horizontal graticule line, the ground reference will not be stored. When using ADD VERTICAL MODE, both channel input coupling switches must be in GND to store a ground reference.

5. Set the selected channel AC-GND-DC switch to DC. An intensified ground reference dot is visible at the left edge (the first sample location of the waveform display) of the crt graticule.

NOTE

If the vertical position of the display is moved after the ground reference is stored, the displayed ground reference is no longer a valid reference. Also, the accuracy of the ground reference is affected by dc offsets due to thermal drift and balance (DC and INVERT) adjustments. Additionally, if the AC-GND-DC switch is set to AC, the location of the ground reference indicates the average value of the ac component of a waveform.

6. Set the POSITION CURS/SELECT WAVEFORM switch to the POSITION CURS position (button in).

7. Use the CURSORS control to move the active cursor to the ground reference point.

8. Push the SELECT C1/C2 button to select the other cursor. The nonmoving cursor is now the 0-volt reference for making measurements on the waveform.

9. Use the CURSORS control to move the active cursor to the point of interest on the waveform (see Figure 6-2).

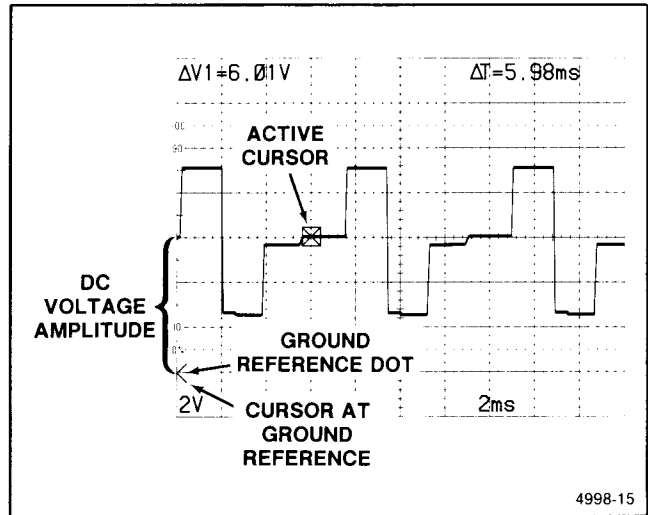

Figure 6-2. Ground referenced dc voltage, cursor method.

10. Read the unsigned dc voltage from the readout.

Time Duration

1. Preset instrument controls and obtain a baseline trace.

2. Set the STORE/NON STORE switch to the STORE position (button in).

3. Select a VOLTS/DIV switch setting that gives the desired vertical deflection.

4. Set the A SEC/DIV switch to display one complete period of the waveform to be measured (see Figure 6-3).

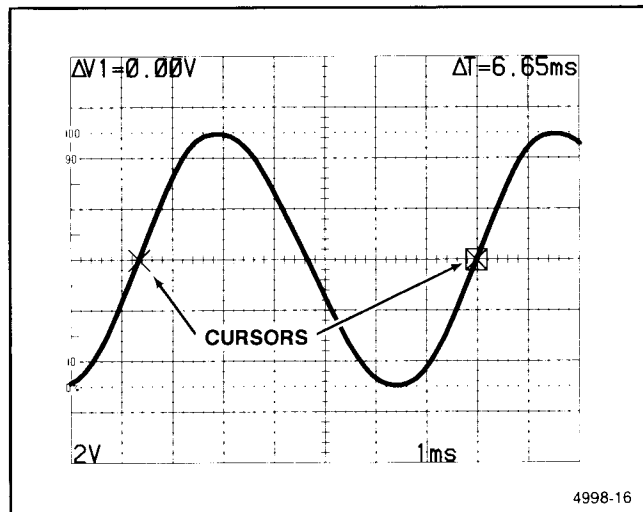

Figure 6-3. Time duration, cursor method.

SAVE REF/→ Switch—When pressed, the next (to the right) Menu level is entered.

Menu Select/DISPLAY ON/OFF Switches—These three buttons select choices presented in the MENU. The ← button recalls the previous (to the left, higher) Menu level. The ↑ button selects the previous entry in the **current** Menu level. The ↓ button selects the next entry in the current Menu level.

MENU SELECTED FUNCTIONS

This part describes the Menu selected functions that provide selection of parameters, settings, and features not controlled by the front-panel switches.

ACQ MODE SETUP TABLE

ACQ MODE SETUP TABLE controls the acquisition mode setup using a table.

DEFAULT—Selects the default acquisition modes for all sweep speeds (see Table 3-2 for the default modes).

SELECT MODE—Displays the acquisition modes in a table. The desired modes for each sweep speed may be selected using the SEC/DIV switch to select the column, the CURSORS Position control selects the row, and the SELECT C1/C2 switch toggles the choice for the table position that is enclosed in a box.

SWP LIMIT—Selects the number of acquisitions before the acquisition system halts in either ACCPEAK or AVERAGE. The acquisition system may be reset by pressing the SELECT C1/C2 switch.

WEIGHT—Selects the weight of the last sample in AVERAGE mode.

A TRIG POS

A TRIG POS selects the number of points acquired prior to or following the trigger.

DISPLAY

DISPLAY controls the selection of display parameters.

DELTA T MODE—Selects either DELTA TIME or ONE OVER DELTA TIME for display in the readout.

VECTORS ON/OFF—Selects either DOTS or VECTORS as the waveform display mode. Vectors are not allowed in REPETITIVE mode.

SMOOTH ON/OFF—Selects the process with which the vector displays are produced when in PEAKDET or ACCPEAK.

With SMOOTH OFF, no reordering of the data points is done, and vectors are drawn between all of the minimum and maximum data points.

With SMOOTH ON, data points are reordered for correct slope and interpolated for drawing a smooth waveform. Smoothing looks at the change in value of reordered data points between adjacent sample intervals. If the change in value does not exceed certain limits, the values are interpreted as a continuous slope for drawing either vectors or dots. If the value change exceeds the interpreted “no-change” limit, the data point value is not modified, and the vectors drawn in the display show a discontinuity in the waveform. This method of display of the waveform data provides a smoothed display of the waveform, yet retains the glitch-catching capabilities of PEAKDET or ACCPEAK modes.

FORMATTING

FORMATTING selects a SAVE REF memory for formatting. The vertical gain, horizontal gain, and vertical position of the selected reference waveform may be changed. The acquisition mode used to store the waveform may also be displayed.

TARGET REFERENCE—Selects one of the SAVE REF memories for formatting.

VGAIN—Allows adjustment of the vertical gain of SAVE REF memories.

VPOSITION—Allows adjustment of the vertical position of SAVE REF memories.

HMAG—Turns X10 horizontal magnification of SAVE REF memories on or off.

MODE—Displays the parameters used to acquire a SAVE REF memory.

PLOT

PLOT controls the transmission of waveforms over the X-Y Plotter output.

MAKING DIGITAL STORAGE MEASUREMENTS

The following procedures will enable the operator to perform some basic measurements and familiarize the operator with digital storage measurement techniques.

Ac Peak-To-Peak Voltage Using Cursors

NOTE

Either channel input connector may be used for the signal input. Use the VERTICAL MODE switches to select the appropriate channel for display.

1. Preset instrument controls and obtain a baseline trace.
2. Set the STORE/NON STORE switch to the STORE position (button in).
3. Select a VOLTS/DIV switch setting that gives the desired vertical deflection.
4. Set the A SEC/DIV switch to display several cycles of the waveform.
5. Two cursors are displayed on the waveform to be measured. The boxed cursor is the active (selected) cursor.
6. Set the POSITION CURS/SELECT WAVEFORM switch to the POSITION CURS position (button in).
7. Use the CURSORS control to move the active cursor to either peak of the waveform.
8. Push the SELECT C1/C2 button to select the other cursor, and use the CURSORS control to move the cursor to the opposite peak of the waveform (see Figure 6-1).

NOTE

After the waveform is acquired, the SAVE Storage mode may be selected. This mode holds the waveform frozen and reduces the amount of cursor jitter seen in the display. The SAVE display may be expanded horizontally and vertically for a more detailed examination of the waveform (see SAVE Mode Display).

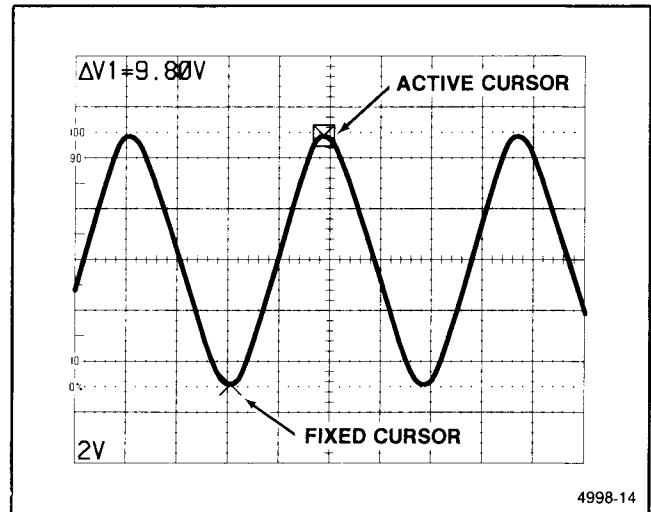

Figure 6-1. Ac peak-to-peak voltage, cursor method.

9. Read the peak-to-peak amplitude from the DELTA VOLTS readout. If the VOLTS/DIV Variable control is out of the calibrated detent, the DELTA VOLTS readout switches to RATIO.

Ground Referenced Dc Voltage

NOTE

Either channel input connector may be used for the signal input. Use the VERTICAL MODE switches to select the appropriate channel for display.

1. Preset instrument controls and obtain a baseline trace.
2. Determine the polarity of the voltage to be measured as follows:
 - a. Set the AC-GND-DC switch to GND and vertically position the baseline trace to the center horizontal graticule line.
 - b. Set the AC-GND-DC switch to DC.

If the waveform moves above the center line of the crt, the voltage is positive.

If the waveform moves below the center line of the crt, the voltage is negative.

START—Initiates the transmission of a waveform over the X-Y Plotter output.

GRATICULE ON/OFF—Enables or disables plotting of the graticule.

ADVANCED FUNCTIONS

REFERENCE—Allows a SAVE REF memory to be Erased or Copied.

ERASE—Selects and erases a SAVE REF memory.

COPY—Selects and copies one SAVE REF memory to another SAVE REF memory.

COMM—Allows the selection of parameters for optional communications options, when they are present.

ACQ MODE SETUP TREE—Controls the acquisition mode setup using a tree. This provides control of the same functions as the ACQ MOD SETUP TABLE.

DEFAULT—Selects the default acquisition modes for all sweep speeds (see Table 3-2 for the default modes).

REPETITIVE—Selects the acquisition modes for sweep speeds from 0.05 μ s to 2 μ s per division.

FAST RECORD—Selects the acquisition modes for sweep speeds from 5 μ s to 10 μ s per division.

SLOW RECORD—Selects the acquisition modes for sweep speeds from 20 μ s to 50 ms per division.

SLOW TRIGGERED—Selects the triggered acquisition modes for sweep speeds from 0.1 to 5 s per division or EXT CLOCK.

SLOW UNTRIGGERED—Selects the untriggered acquisition modes for sweep speeds from 0.1 to 5 s per division or EXT CLOCK.

DIAGNOSTICS—Controls the selection of diagnostic TESTS, EXERCISERS, and PICTURES.

Acquisition Modes

PEAK DETECT (PEAKDET) and SAMPLE (NORMAL)—Select how samples are processed on successive acquisitions. See Table 3-2 for the default modes set by the SEC/DIV switch.

In Peak Detect mode, the minimum and maximum levels of the input signal within the time represented by 1/50 of a division unmagnified (1/25 of a division in CHOP or ALT) are digitized and stored in acquisition memory as a data pair. The displayed data points are connected by vectors.

In Sample mode, the signal is sampled at a rate that produces 100 samples per graticule division. In RECORD sampling, the displayed sample points are connected by either vectors or dots. For REPETITIVE Storage mode, the sample points are displayed as dots.

ACCPEAK—Will cause displays to accumulate. The largest maximum and smallest minimum sample acquisitions are retained for each trigger-referenced sample record over multiple acquisition cycles. When ACCPEAK is used with hardware peak detection (50 μ s per division to 0.1 s per division), updating of maximum and minimum samples also occurs within each time-base clock period. Changing any switch that affects the acquisition parameters resets ACCPEAK displays. ACCPEAK mode is valid for triggered acquisitions only and is not operational in any mode that does not allow triggers (see Table 3-2).

AVERAGE—Is used for multiple record averaging. Whenever AVERAGE is selected, SAMPLING is also selected automatically. When on, a normalized algorithm is used for continuous display of the signal at full amplitude during the averaging process. Averaging is the default for REPETITIVE Store mode only. The amplitude resolution increases with the number of weighted acquisitions included in the display. The number of weighted acquisitions included in the AVERAGE display is Menu selectable. The default weight of AVERAGE mode is 1/4. Other choices are Menu selectable. The number of sweeps (SWP LIMIT) allowed to occur before averaging stops is also Menu selectable.

REAR PANEL

Refer to Figure 3-6 for location of items 43 through 45.

- 43 **EXT Z-AXIS Input Connector**—Provides an input connector allowing external signals to be applied to the Z-Axis circuit to intensity modulate the NON STORE waveform display. Applied signals do not affect the display waveshape. External signals with fast rise and fall times provide the best defined intensity modulation. Noticeable intensity modulation is produced at normal viewing intensity levels by a 5 V p-p signal. The Z-Axis signals must be time-related to the trigger signal to obtain a stable intensity-modulation pattern on the displayed waveform.

Basic Applications—2230 Operators

SAVE REF Display

1. Acquire the waveform to be used as a reference using the previous "SAVE Mode Display" procedure.
2. Push in the SAVE REF push button.
3. Push in one of the DISPLAY ON/OFF buttons. The waveform is stored in the Reference MEMORY selected by the DISPLAY ON/OFF button pushed.
4. If the SAVE REF display contains the active cursor, use the Menu to horizontally expand or compress the SAVE REF display by a factor of up to 10 times, if desired. The display is expanded horizontally in both directions from the active cursor and is correctly scaled for the switch settings. A waveform acquired at 2 mV per division cannot be vertically expanded, and a waveform acquired at 5 V per division cannot be vertically compressed.
5. Push the appropriate DISPLAY ON/OFF button (without first pushing the SAVE REF button) to retrieve and display a stored reference waveform. A new reference waveform is saved each time the SAVE REF button is pushed and then a DISPLAY ON/OFF button is pushed.

ACCPEAK or PEAKDET Displays

1. Preset the instrument controls and obtain a baseline display.
2. Set the STORE/NON STORE switch to the STORE position (button in).
3. Adjust the A TRIGGER LEVEL control to obtain a stable display of the waveform to be stored. This ensures that the trigger and the waveform to be stored are synchronized, especially on low-repetition-rate waveforms.
4. Select either PRETRIG ACQUISITION mode to acquire 7/8 of the waveform before the trigger event or POST TRIG ACQUISITION mode to acquire 7/8 of the waveform that occurs after the trigger.

NOTE

Using the MENU, the trigger point can be selected to be any point within the acquisition record.

5. Set the WAVEFORM REFERENCE/MENU SELECT switch to the MENU SELECT position (button out).

6. Use the MENU SELECT switches to select ACCPEAK or PEAKDET.

7. Set the WAVEFORM REFERENCE/MENU SELECT switch to the WAVEFORM REFERENCE position (button in).

AVERAGE Mode Display

1. Preset the instrument controls and obtain a baseline display.
2. Set the STORE/NON STORE switch to the STORE position (button in).
3. Adjust the A TRIGGER LEVEL control to obtain a stable display of the waveform to be stored. This ensures that the trigger and the waveform to be stored are synchronized, especially on low-repetition-rate waveforms.
4. Select either PRETRIG ACQUISITION mode to acquire 7/8 of the waveform before the trigger event or POST TRIG ACQUISITION mode to acquire 7/8 of the waveform that occurs after the trigger.
5. Set the WAVEFORM REFERENCE/MENU SELECT switch to the MENU SELECT position (button out).
6. Use the MENU SELECT switches to select AVERAGE.
7. Use the Menu to change the number of sweeps accumulated in the display before the Averaging (acquisitions) stop, if desired. The number is automatically set to infinity at power-up.
8. Use the Menu to change the Weight of the last (current) acquisition in the average, if desired. The Weight is automatically set to 1/8 at power-up.

NOTE

The Weight of the last (current) acquisition to be averaged into the display is selectable from 1/2 to 1/256 in powers of 2. A normalized algorithm is used to display the averaged signal. Averaging continues until a new mode is selected or SWP LIMIT is reached. Display of the average continues until a new mode is selected. Changing a front-panel control that affects the data being acquired restarts the averaging process; the algorithm displays the new average at full amplitude.

Controls, Connectors, and Indicators—2230 Operators

- 44 **Fuse Holder**—Contains the ac-power-source fuse. See the rear panel nomenclature for fuse rating and line voltage range.
- 45 **Detachable Power Cord Receptacle**—Provides the connection point for the ac-power source to the instrument.

SIDE PANEL

The standard side panel includes one AUXILIARY CONNECTOR. Refer to Figure 3-7 for the location of item 46.

- 46 **AUXILIARY CONNECTOR**—Provides connections for an X-Y Plotter and an External Clock input (see Table 3-4).

NOTE

To avoid causing interference to other instruments, use a shielded cable for connections to the AUXILIARY CONNECTOR.

X-Y Plotter Connections—Provide connections for X-Axis output, Y-Axis output, and Pen Lift

control to drive an external X-Y Plotter. All displayed waveforms and the crt readout are transmitted over the Plotter Interface. The settling time allowed for each movement is approximately proportional to the distance of the movement. Connections for Signal Ground and Shield Ground are also provided for grounding between the instrument and the external X-Y Plotter. Waveforms and the Readout are plotted on the crt while a plot is in progress.

Table 3-4
Auxiliary Connector

Pin Number	Function
1	EXT CLK Input
2	Pen Lift, Normally Closed
3	X Output
4	SHIELD GND
5	Y Output
6	+4.2 V
7	Pen Lift, Normally Open
8	Pen Lift, Relay Common
9	SIG GND

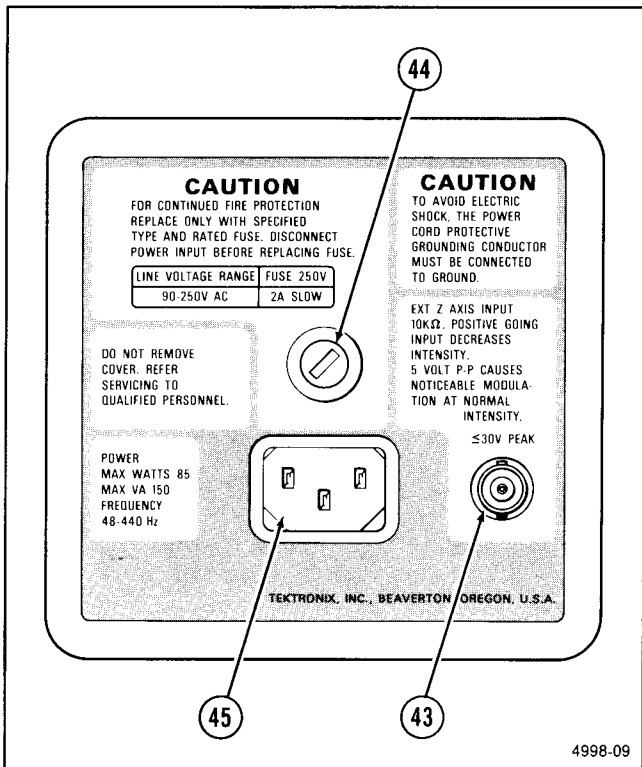

Figure 3-6. Rear panel.

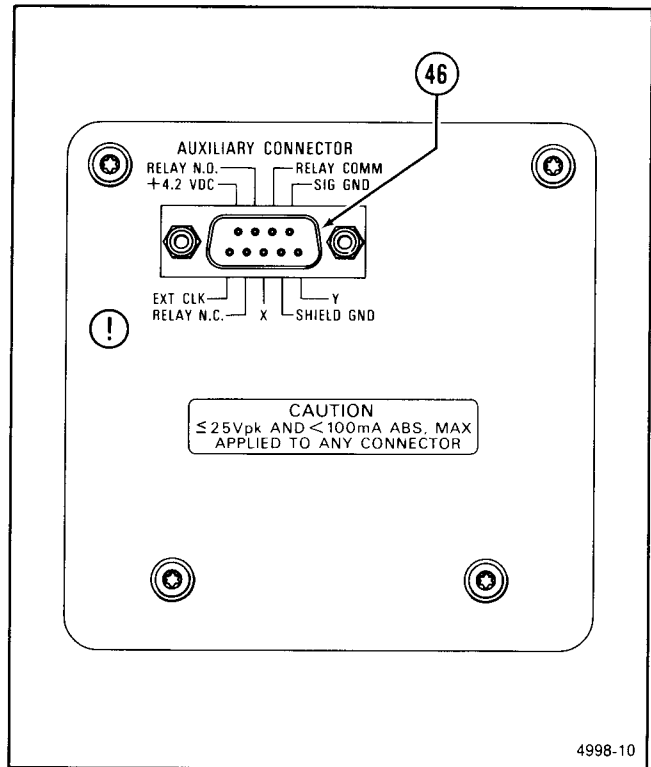

Figure 3-7. Side panel.

4. Set the VERTICAL MODE switch to X-Y (button in).

5. Advance the A INTENSITY control until the display is visible. If the display is not visible with the A INTENSITY control at midrange, press and hold in the BEAM FIND push button while adjusting the Channel 1 and Channel 2 VOLTS/DIV switches until the display is reduced in size, both vertically and horizontally. Center the compressed display with the POSITION controls (Channel 2 POSITION control for vertical movement; Horizontal POSITION control for horizontal movement). Release the BEAM FIND push button. Adjust the FOCUS control for a well-defined display.

NOTE

The display obtained when sinusoidal signals are applied to the X- and Y-axis is called a Lissajous Figure. This display is commonly used to compare the frequency and phase relationship of the two input signals. The frequency relationship of the two input signals determines the pattern seen. The pattern will be stable only if a common divisor exists between the two frequencies.

6. Set the X-Y switch to the out position and disconnect the input signals from the vertical input connectors.

Single Sweep Display

1. Preset the instrument controls and obtain a baseline display.
2. For random signals, set the A TRIGGER LEVEL control to trigger the sweep on a signal that is approximately the same amplitude as the random signal.
3. Press in the SGL SWP RESET button for a moment. The next trigger pulse will initiate the sweep, and a single trace will be displayed. If no trigger signal is present, the READY indicator LED should illuminate to indicate that the A SWEEP Generator circuit is set to initiate a sweep when a trigger signal is received.
4. When the single sweep has been triggered and the sweep is completed, the sweep logic circuitry is locked out. Another sweep cannot be generated until the SGL SWP RESET button is pressed in to set the A Sweep Generator to the READY condition.

DIGITAL STORAGE DISPLAYS

The following procedures explain how to set up and use the digital storage capabilities of the instrument. A combination of front-panel controls and Menu selections sets the conditions under which a waveform is acquired for display. Display amplitude is controlled by the VOLTS/DIV switches. The storage time base is controlled by the A or B SEC/DIV switch, and the CURSORS controls. Certain conditions of the SEC/DIV switch and the TRIGGER Mode switch will acquire and display waveforms using default parameters. Using the Menu, many of the defaults may be changed. See Table 3-2 for a listing of the default selections and optional choices.

STORE Mode Display

1. Preset instrument controls and obtain a baseline trace.
2. Set the PRETRIG/POST TRIG switch for the desired trigger position.
3. Set the STORE/NON STORE switch to the STORE position (button in).

SAVE Mode Display

1. Acquire a waveform using one of the storage modes.
2. Set the SAVE/CONTINUE switch to the SAVE position (button in).
3. The SAVE mode display may be expanded horizontally by both the X10 Magnifier switch and the SEC/DIV switch. The display is expanded horizontally in both directions from the active cursor and is correctly scaled for the switch settings.
4. The SAVE mode display may be expanded or compressed vertically by a factor of 10 times (or by as many VOLTS/DIV switch positions remaining—whichever is less) by switching the corresponding VOLTS/DIV switch (a waveform acquired at 2 mV per division cannot be expanded, and a waveform acquired at 5 V per division cannot be compressed).
5. Saved waveforms may be repositioned using the Menu even if they have been expanded or compressed.

To be fully compatible, the X-Y Plotter used must have X and Y inputs with sensitivity control and penlift control.

Signals available at the AUXILIARY CONNECTOR allow the Pen Lift circuit to be wired for a plotter with either active HI or active LO drive requirements and several logic families. Examples for both an active HI and an active LO TTL drive are shown in Figure 3-8.

EXT CLK Input—Provides an input for EXT CLOCK signals (up to 1000 samples per second) to the storage acquisition circuitry in conjunction with the EXT CLK position of the A SEC/DIV switch. Samples are referenced by falling edges. Input is TTL compatible. Samples become visible by pairs, as SCAN or ROLL. Several clocks are required before the point associated with the first clock is visible.

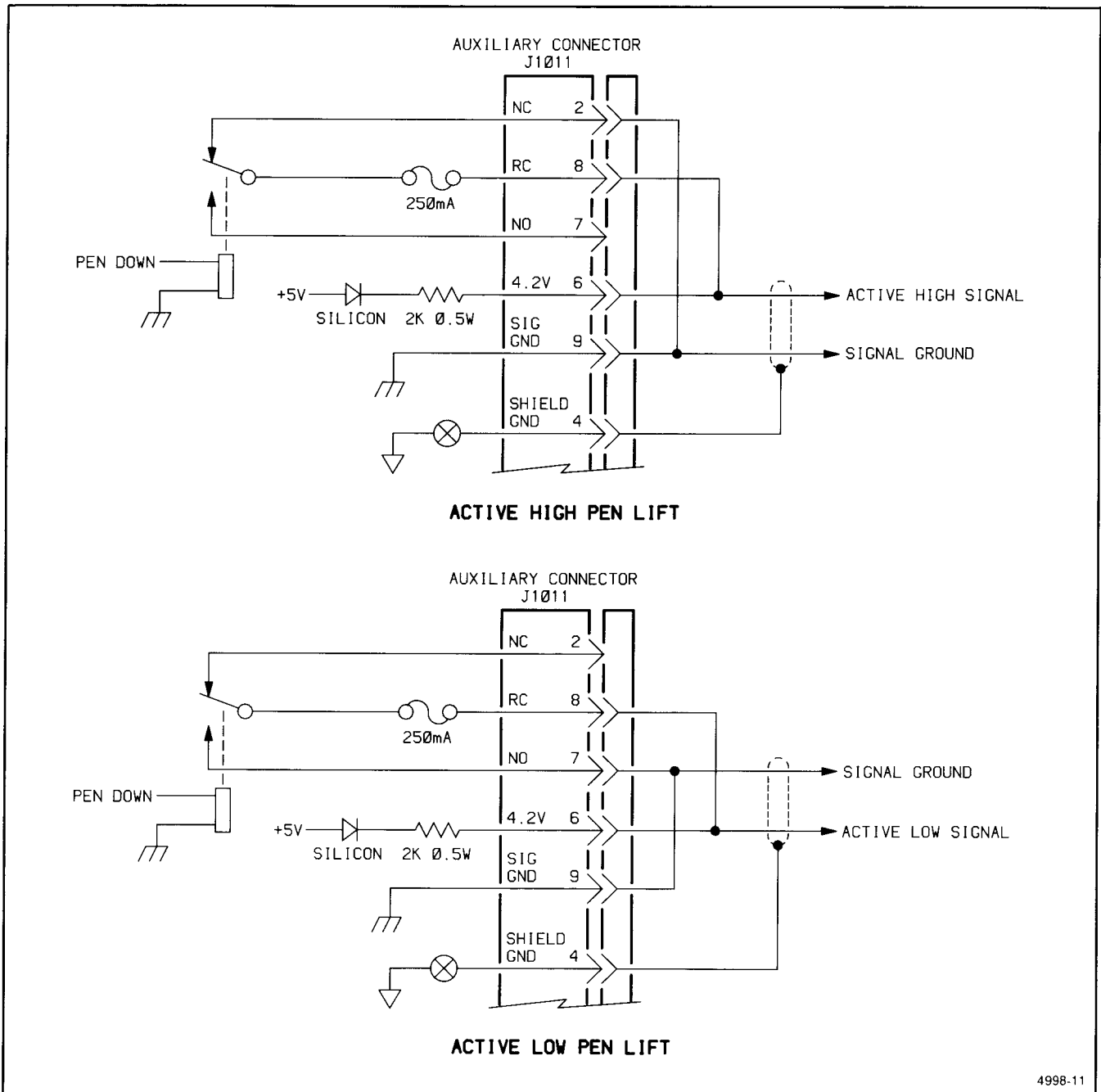

Figure 3-8. X-Y Plotter interfacing.

Magnified Sweep Display

1. Preset the instrument controls and obtain a baseline display.
2. Adjust the Horizontal POSITION control to move the area to be magnified to within the center crt graticule division (0.5 division on each side of the center vertical graticule line). Change the SEC/DIV switch setting as required.
3. Pull out the SEC/DIV Variable knob and adjust the Horizontal POSITION control for precise positioning of the magnified display.
4. To calculate the magnified sweep rate, divide the SEC/DIV switch setting by 10.

B Delayed Sweep Display

1. Preset the instrument controls and obtain a baseline display.
2. Set the HORIZONTAL MODE switch to BOTH and the B TRIGGER LEVEL control to B RUNS AFTER DLY.
3. Pull out the B SEC/DIV knob to unlock it from the A SEC/DIV knob and turn it clockwise from the counter-clockwise stop until the intensified zone is the desired length. Adjust the A INTENSITY and B INTENSITY controls as required to make the intensified zone distinguishable from the remainder of the display.
4. Adjust the B DELAY TIME POSITION control to move the intensified zone to cover the portion of the A trace that is to be displayed on the B trace.
5. Set the HORIZONTAL MODE switch to B. The intensified zone adjusted in steps 3 and 4 is now displayed as the B trace at the sweep rate indicated by the B SEC/DIV switch.
6. A more stable display with less jitter may be obtained by adjusting the B TRIGGER LEVEL control for a triggered B Sweep.

NOTE

The B DELAY TIME POSITION control will not provide continuously variable delay when the B TRIGGER LEVEL control is set to a position other than B RUNS AFTER DLY. Also, differential time measurements are invalid when the B TRIGGER LEVEL control is not set to B RUNS AFTER DLY.

Alternate Horizontal Sweep Display

1. Preset the instrument controls and obtain a baseline display.
2. Set the HORIZONTAL MODE switch to BOTH and the B TRIGGER LEVEL control to B RUNS AFTER DLY.

NOTE

Two traces will be visible; the A trace with an intensified zone, and the B delayed trace without the intensified zone.

3. Adjust the Channel 1 POSITION control and the A/B SWP SEP control as required to display the A trace above the B trace.
4. Pull out the B SEC/DIV knob to unlock it from the A SEC/DIV knob and turn it clockwise to the desired B Sweep rate.
5. Adjust the A and the B INTENSITY controls as required to make the intensified zone distinguishable on the A trace and to set the B trace intensity to the desired brightness.
6. Adjust the B DELAY TIME POSITION control to move the intensified zone to cover the portion of the A trace that is to be displayed on the B trace.

X-Y Display

1. Preset the instrument controls and obtain a baseline display.
2. Rotate the A INTENSITY control fully counterclockwise and disconnect the CH 1 input signal.
3. Use two coaxial cables or probes of equal delay and apply the vertical signal (Y-axis) to the CH 2 OR Y input connector and horizontal signal (X-axis) to the CH 1 OR X input connector.

CRT READOUT

The Readout System provides an alphanumeric display of information on the crt along with the waveform displays. The readout (non MENU) is displayed in three rows of characters. Two rows are within the top graticule division, and the other row is within the bottom graticule division. The locations and types of information displayed under normal operating modes are illustrated in Figure 3-9.

NON STORE Mode

In NON STORE mode the current settings of the VOLTS/DIV and SEC/DIV switches are displayed. Greater-than symbols (>) are used to indicate uncalibrated VOLTS/DIV and SEC/DIV switch settings. A down-arrow symbol (↓) is used in front of the CH 2 VOLTS/DIV readout to indicate CH 2 INVERT. For Horizontal Display Mode of BOTH and B only, the DELAY TIME POSITION readout is also displayed. The AC-GND-DC input coupling selection is indicated in the associated VOLTS/DIV readout with a tilde symbol (~) above the volts symbol for AC, a ground symbol (⊥) for GND, and no extra symbol for DC input coupling.

STORE Mode

In STORE mode, many of the crt readout displays are associated with the parameters of stored waveforms.

PARAMETER READOUT. Displays the VOLTS/DIV, SEC/DIV and B DELAY TIME settings of the displayed waveforms on which the intensified cursors are placed. The AC-GND-DC input coupling selection is indicated in the associated VOLTS/DIV readout with a tilde symbol (~) above the volts symbol for AC, a ground symbol (⊥) for GND, and no extra symbol for DC input coupling. If the VOLTS/DIV switch is switched beyond the available expansion or compression range, the readout is tilted, indicating that the VOLTS/DIV switch setting and the VOLTS/DIV readout no longer agree.

CURSOR READOUT. Displays the voltage difference (either $\Delta V 1$ or $\Delta V 2$) and the time difference between cursors. When either BOTH or B HORIZONTAL mode is selected, the DELAY TIME POSITION is displayed. Independent fields for CH 1 VOLTS/DIV, CH 2 VOLTS/DIV, A SEC/DIV, and B SEC/DIV are provided.

When the acquisition record length is longer than one screen (1K), a bar graph is used to indicate the position of the display window within the acquisition record.

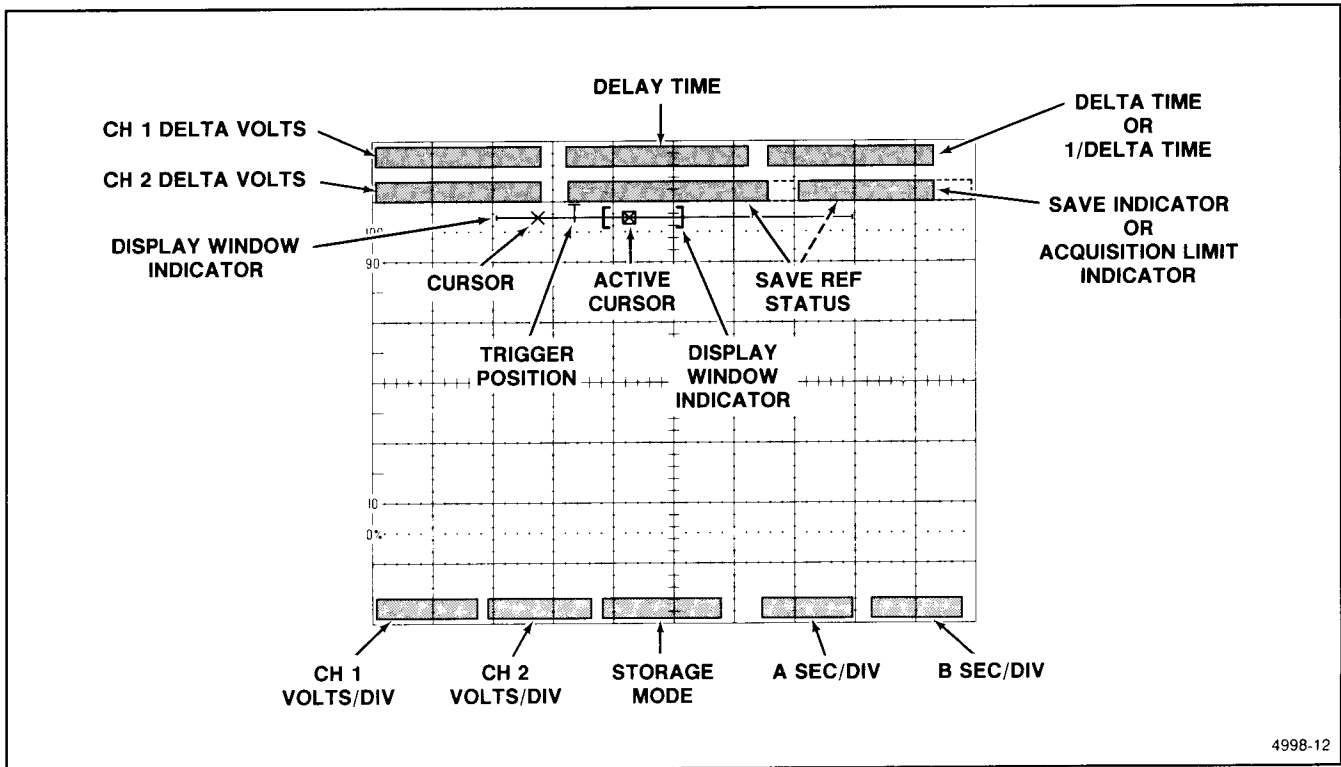

Figure 3-9. Crt readout display.

BASIC APPLICATIONS

INTRODUCTION

The procedures in this section enable the operator to make basic measurements using the capabilities of the oscilloscope. Many of these measurements can be obtained with either the nonstorage mode or one of the storage modes. After becoming familiar with the capabilities of the instrument, the operator can choose the best method for making a particular measurement. Read the "Operating Considerations" part of this manual for information on signal connections, grounding, and other general operating information that may be useful in your application.

When the procedures call for obtaining a baseline display, refer to Initial Setup in the "Operator's Checks and Adjustments" part of this manual. The initial control settings listed in the Initial Setup procedure are considered as the initial control setup. Alternate control settings are usually required for making a specific measurement. The operator must determine the correct control settings applicable to VOLTS/DIV, SEC/DIV, TRIGGER, and other controls to obtain a stable display of the desired display. Only the readouts necessary for each specific example are shown in their associated illustrations.

OSCILLOSCOPE DISPLAYS

The following procedures will allow the operator to set up and operate the instrument to obtain the most commonly used oscilloscope displays. Verify that the POWER switch is OFF (push button out), then plug the power cord into the ac-power-input source outlet.

NON STORE DISPLAYS

The following procedures are used to obtain the most commonly used conventional oscilloscope displays.

Normal Sweep Display

1. Preset the instrument controls and obtain a baseline display.
2. Using the supplied 10X probe or a properly terminated coaxial cable, apply a signal to the CH 1 OR X input connector. The signal source output impedance determines the termination required when using a coaxial cable to interconnect test equipment.

3. Advance the A INTENSITY control until the display is visible. If the display is not visible with the INTENSITY control at midrange, press the BEAM FIND push button and hold it in while adjusting the Channel 1 VOLTS/DIV switch to reduce the vertical display size. Center the compressed display using the Vertical and Horizontal POSITION controls. Release the BEAM FIND push button.

4. Set the Channel 1 VOLTS/DIV switch and the Vertical and Horizontal POSITION controls to locate the display within the graticule area.

5. Adjust the A TRIGGER LEVEL control for a stable, triggered display.

6. Set the A SEC/DIV switch for the desired number of cycles of displayed signal. Then adjust the FOCUS control for the best defined display.

NOTE

Instrument warm up time required to meet all specification accuracies is 20 minutes.

OPERATING CONSIDERATIONS

This part contains basic operating information and techniques that should be considered before attempting to make any measurements with the instrument.

GRATICULE

The graticule is internally marked on the faceplate of the crt to eliminate parallax-viewing errors and to enable measurements (see Figure 4-1). The graticule is marked with eight vertical and ten horizontal major divisions. In addition, each major division is divided into five subdivisions. The vertical deflection factors and horizontal timing are calibrated to the graticule so that accurate measurements can be made directly from the crt. Also, percentage marks for the measurement of rise and fall times are located on the left side of the graticule.

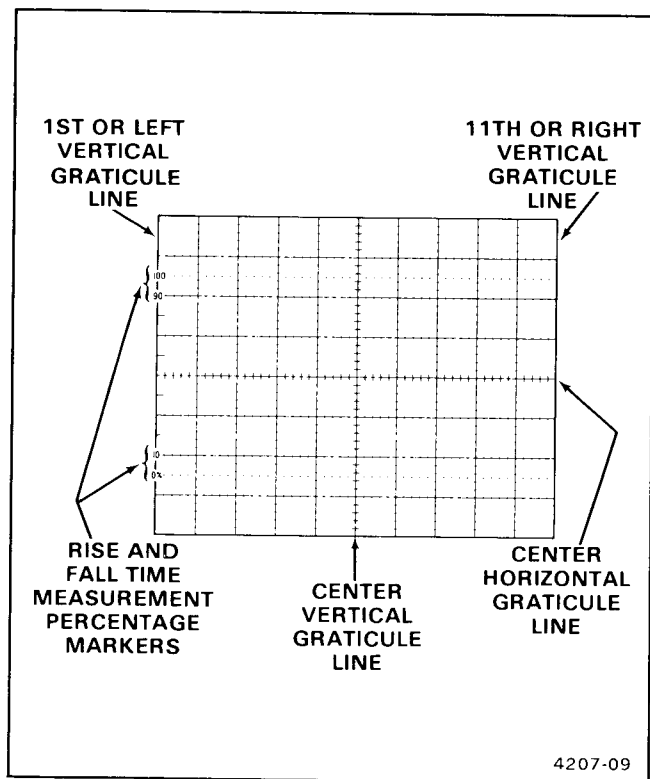

Figure 4-1. Graticule measurement markings.

GROUNDING

The most reliable signal measurements are made when the oscilloscope and the unit under test are connected by a common reference (ground lead) in addition to the signal lead or probe. The probe's ground lead provides the best grounding method for signal interconnection and ensures the maximum amount of signal-lead shielding in the probe cable. A separate ground lead can also be connected from the unit under test to the oscilloscope GND receptacle located on the oscilloscope's front panel.

SIGNAL CONNECTIONS

Probes

Generally, the accessory probes supplied with the instrument provide the most convenient means of connecting a signal to the vertical inputs of the instrument. The probe and probe lead are shielded to prevent pickup of electromagnetic interference, and the 10X attenuation factor of the probe offers a high input impedance that minimizes signal loading in the circuitry under test. The attenuation factor of the standard accessory probe is coded so that the VOLTS/DIV readout seen on the crt is automatically switched to the correct scale factor when the probe is attached.

Both the probe itself and the probe accessories should be handled carefully at all times to prevent damage to them. Avoid dropping the probe body. Striking a hard surface can cause damage to both the probe body and the probe tip. Exercise care to prevent the cable from being crushed or kinked. Do not place excessive strain on the cable by pulling.

The standard-accessory probe is a compensated 10X voltage divider. It is a resistive voltage divider for low frequencies and a capacitive voltage divider for high-frequency signal components. Inductance introduced by either a long signal or ground lead forms a series-resonant circuit. This circuit will affect system bandwidth and will ring if driven by a signal containing significant frequency

Operating Considerations—2230 Operators

components at or near the circuit's resonant frequency. Oscillations (ringing) can then appear on the oscilloscope waveform display and distort the true signal waveshape. Always keep both the ground lead and the probe signal-input connections as short as possible to maintain the best waveform fidelity.

Misadjustment of probe compensation is a common source of measurement error. Due to variations in oscilloscope input characteristics, probe compensation should be checked and adjusted, if necessary, whenever the probe is moved from one oscilloscope to another or between channels. See the probe compensation procedure in "Operator's Check and Adjustments", or consult the instructions supplied with the probe.

Coaxial Cables

Cables may also be used to connect signals to the vertical input connectors, but they may have considerable effect on the accuracy of a displayed waveform. To maintain the original frequency characteristics of an applied signal, only high-quality, low-loss coaxial cables should be used. Coaxial cables should be terminated at both ends in their characteristic impedance. If this is not possible, use suitable impedance-matching devices.

INPUT-COUPLING CAPACITOR PRECHARGING

When the Input Coupling switch is set to the GND position, the input signal is connected to ground through the input-coupling capacitor and a high resistance value. This series combination forms a precharging circuit that allows the input-coupling capacitor to charge to the average dc voltage level of the signal applied to the input connector. Thus, any large voltage transients that may accidentally be generated are not applied to the vertical amplifier's input when the input coupling is switched from GND to AC. The precharging network also provides a measure of protection to the external circuitry by reducing the current level that is drawn from the external circuitry while the input-coupling capacitor is charging.

If AC input coupling is in use, the following procedure should be followed whenever the probe tip is connected to a signal source having a different dc level than that previously applied. This procedure becomes especially useful if the dc-level difference is more than ten times the VOLTS/DIV switch setting.

1. Set the AC-GND-DC (input coupling) switch to GND before connecting the probe tip to a signal source.

2. Touch the probe tip to the oscilloscope GND connector.

3. Wait several seconds for the input-coupling capacitor to discharge.

4. Connect the probe tip to the signal source.

5. Wait several seconds for the input-coupling capacitor to charge to the dc level of the signal source.

6. Set the AC-GND-DC switch to AC. A signal with a large dc component can now be vertically positioned within the graticule area, and the ac component of the signal can be measured in the normal manner.

HORIZONTAL ACCURACY CHECK

A check of the horizontal timing can be made using the time measurement capability of the CURSOR measurement mode:

1. Preset instrument controls and obtain a baseline trace as described in "Initial Setup".

2. Set:

CH 1 AC-GND-DC	GND
STORE/NON STORE	STORE (button in)
A SEC/DIV	1 ms
PRETRIG/POST TRIG	POST TRIG (button out)
POSITION CURS/ SELECT WAVEFORM	POSITION CURS (button in)

3. Turn the Horizontal POSITION control to align the start of the trace to the first vertical graticule line.

4. Turn the Vertical POSITION control to align the baseline trace with the center horizontal graticule line.

5. Position the active cursor to the second vertical graticule line using the CURSORS Position control.

6. Push the SELECT C1/C2 switch to activate the other cursor.

7. Position the active cursor to the tenth vertical graticule line using the CURSORS Position control for a spacing of eight divisions between cursors.

8. Check that the Delta Time readout is ≥ 7.84 ms and ≤ 8.16 ms.

9. Verify that the CH 1 probe tip is in the PRB ADJ connector.

10. Set the CH 1 AC-GND-DC switch to DC.

11. Adjust the SEC/DIV switch setting for a display of at least one full period of the probe adjust signal (0.1 or 0.2 ms per division).

12. Use the Vertical and Horizontal POSITION controls to center the display.

13. Use the CURSORS Position control and the CURSORS SELECT C1/C2 button to align the cursors with the rising edges of the PRB ADJ signal (measurement is of the probe adjust signal period). Note the cursor time difference readout and the graticule measurement (horizontal distance between rising edges as taken from the graticule markings) of the signal for later reference.

14. Check that the cursor readout of the probe adjust signal period and the graticule measurement of the calibrator period are within $\pm 2\%$.

15. Set the STORE/NON STORE switch to the NON STORE position (button out).

16. Determine the horizontal graticule measurement of the probe adjust signal period. Note the reading for later reference.

17. Check that the NON STORE Mode probe adjust signal period measurement obtained from the graticule markings is within $\pm 3\%$ of the STORE Mode probe adjust signal period obtained in step 13.

18. Set the X10 MAG switch to on (pull Var Sec/Div knob out) and set the A SEC/DIV switch setting to obtain a display of at least one full period of the probe adjust signal (0.1 or 0.2 ms per division).

19. Check that the magnified NON STORE Mode probe adjust signal period measurement obtained from the graticule markings is within $\pm 4\%$ of the STORE Mode probe adjust signal period obtained in step 13.

OPERATOR'S CHECKS AND ADJUSTMENTS

To verify the operation and basic accuracy of your instrument before making measurements, perform the following checks and adjustment procedures. If adjustments are required beyond the scope of these operator's checks and adjustments, refer the instrument to qualified service personnel.

For new equipment checks, before proceeding with these instructions, refer to "Preparation for Use" in this manual to prepare the instrument for the initial start-up before applying power.

INITIAL SETUP

1. Verify that the POWER switch is OFF (switch is in the out position), then plug the power cord into the ac power outlet.

2. Press in the POWER switch (ON) and set the instrument controls to obtain a baseline trace:

Display

A and B INTENSITY	Midrange
STORAGE/READOUT INTENSITY	Midrange (with READOUT on)
FOCUS	Best defined display

Vertical (Both Channels)

VERTICAL MODE	CH 1
POSITION	Midrange
VOLTS/DIV	50 mV
AC-GND-DC	DC
Var Volts/Div	CAL (in detent)
BW LIMIT	Off (button out)

Horizontal

HORIZONTAL MODE	A
A SEC/DIV	0.5 ms
Var Sec/Div	CAL (in detent)
POSITION	Midrange
X10 Mag	Off (Var Sec/Div knob in)
B DELAY TIME	
POSITION	Fully counterclockwise

Triggers

VAR HOLDOFF	NORM (fully counterclockwise)
A&B INT	VERT MODE
A SOURCE	INT
A Mode	P-P AUTO
A LEVEL	For a stable display (with signal applied)
A SLOPE	OUT (plus—button out)
B LEVEL	B RUNS AFTER DELAY (fully clockwise)
B SLOPE	OUT (plus—button out)
HF REJECT	OFF (fully counterclockwise)

Storage

STORE/NON STORE	NON STORE (button out)
SAVE/CONTINUE	CONTINUE (button out)
PRETRIG/POST TRIG	POST TRIG (button out)
ROLL/SCAN	SCAN (button out)
1K/4K	4K (button out)
POSITION CURS/ SELECT WAVEFORM	POSITION CURS (button in)
WAVEFORM REFERENCE/MENU SELECT	WAVEFORM REFERENCE (button in)

3. Adjust the INTENSITY and FOCUS controls for the desired display brightness and best focused trace.

4. Adjust the Vertical and Horizontal POSITION controls to position the trace within the graticule area.

5. Allow the instrument to warm up for 20 minutes before commencing the adjustment procedures. Reduce the INTENSITY levels during the waiting time.

TRACE ROTATION ADJUSTMENT

NOTE

Normally, the trace will be parallel to the center horizontal graticule line, and TRACE ROTATION adjustment is not required.

1. Preset the instrument controls and obtain a baseline trace as described in "Initial Setup."
2. Use the Channel 1 POSITION control to move the baseline trace to the center horizontal graticule line.
3. If the baseline trace is not parallel to the center horizontal graticule line, use a small-bladed screwdriver or alignment tool to adjust the TRACE ROTATION control to align the trace with the graticule line.

PROBE COMPENSATION

Misadjustment of probe compensation is a source of measurement error. The attenuator probes are equipped with a compensation adjustment. To ensure optimum measurement accuracy, always check probe compensation before making measurements. Probe compensation is accomplished by:

1. Preset the instrument controls and obtain a baseline trace as described in "Initial Setup."
2. Connect the two 10X probes (supplied with the instrument) to the CH 1 OR X and CH 2 OR Y input connectors. Observe that the CH 1 VOLTS/DIV readout changes from 5 mV to 50 mV when the 10X probe is attached to the CH 1 OR X input.

3. Remove the hook tip from the end of each probe.

NOTE

While the probe tip is in the PRB ADJ connector, use care not to break off the probe tip.

4. Insert the Channel 1 probe tip into the PRB ADJ connector.
5. Use the CH 1 POSITION control to vertically center the display. If necessary, adjust the A TRIGGER LEVEL control to obtain a stable display on the plus (OUT) SLOPE.

6. Check the waveform display for overshoot and rounding (see Figure 5-1); if necessary, use a small-bladed screwdriver to adjust the probe compensation for a square front corner on the waveform.

7. Remove the Channel 1 probe tip from the PRB ADJ connector.

8. Insert the Channel 2 probe tip into the PRB ADJ connector.

9. Set the VERTICAL MODE to CH 2.

10. Set the A TRIGGER A&B INT switch to CH 2.

11. Use the CH 2 POSITION control to vertically center the display.

12. Check the waveform display for overshoot and rounding (see Figure 5-1); if necessary, use a small-bladed screwdriver to adjust the probe compensation for a square front corner on the waveform.

NOTE

Refer to the instruction manual supplied with the probe for more complete information on the probe and probe compensation.

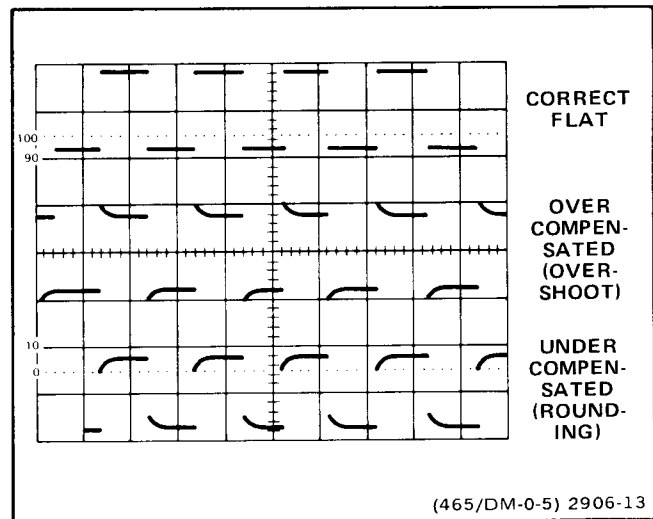

Figure 5-1. Probe compensation.